



**Everything
a good
tiler needs!**



TILER'S MATE[®]

Division of Gilt Edge Industries Ltd

www.tilersmate.co.nz

**TILE DIRECT
NELSON**



Tile Direct
74 Quarantine Road
Stoke
Nelson

Store

Phone: 03 547 8413

Email: nelson@tiledirect.co.nz

Nelson Manager

Paul Kenny
Phone 0274 300 068

Email: paul@tiledirect.co.nz

www.tiledirect.co.nz



TILER'S MATE[®]

Division of Gilt Edge Industries Ltd

INDEX

COMPANY PROFILES & CONTACTS ▶

TILE TRIMS ▶

TOOLS & ACCESSORIES ▶

TILE CUTTERS ▶

DIAMOND TOOLS ▶

SPACERS ▶

SILICONES ▶

SEALERS & CLEANERS ▶

GROUTS, CTA & LEVELLING ▶

GRADUS STAIR NOSING ▶

RUBI ▶

PRICE LIST ▶



ALUMINIUM ROUND EDGE TILE TRIM

ITEM No.	DESCRIPTION	SIZE	PACK SIZE
136474	Round Edge Aluminium	6mm x 2.5m	10
136475	Round Edge Aluminium	8mm x 2.5m	10
136476	Round Edge Aluminium	10mm x 2.5m	10
191649	Round Edge Aluminium	12mm x 2.5m	10



ROUND EDGE ANODISED TILE TRIM

ITEM No.	DESCRIPTION	SIZE	PACK SIZE
152729	Matt (Brushed) Silver	6mm x 2.5m	10
170233	Bright Silver	6mm x 2.5m	10

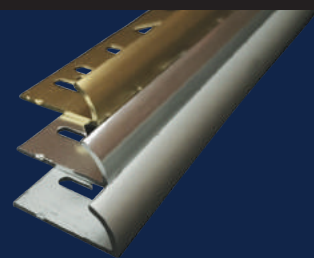

ROUND EDGE ANODISED TILE TRIM

ITEM No.	DESCRIPTION	SIZE	PACK SIZE
152730	Matt (Brushed) Silver	8mm x 2.5m	10
170236	Bright Silver	8mm x 2.5m	10

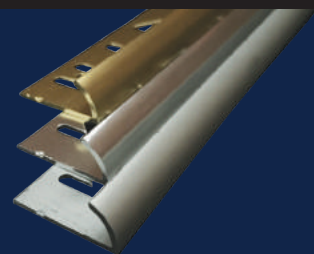

ROUND EDGE ANODISED TILE TRIM

ITEM No.	DESCRIPTION	SIZE	PACK SIZE
152731	Matt (Brushed) Silver	10mm x 2.5m	10
170240	Bright Silver	10mm x 2.5m	10



ROUND EDGE ANODISED TILE TRIM

ITEM No.	DESCRIPTION	SIZE	PACK SIZE
191650	Matt (Brushed) Silver	12mm x 2.5m	10
191654	Bright Silver	12mm x 2.5m	10



ROUND EDGE POWDERCOATED TILE TRIM

ITEM No.	DESCRIPTION	SIZE	PACK SIZE
676567	White	6mm x 2.5m	10
676574	Gloss Black	6mm x 2.5m	10
	OTHER COLOURS P.O.A		



"Please Note: Anodised profiles are 2.5m long but sold as 2.4m due to anodising jig marks"



ROUND EDGE POWDERCOATED TILE TRIM			
ITEM No.	DESCRIPTION	SIZE	PACK SIZE
676568	White	8mm x 2.5m	10
676575	Gloss Black	8mm x 2.5m	10
	OTHER COLOURS P.O.A		



ROUND EDGE POWDERCOATED TILE TRIM			
ITEM No.	DESCRIPTION	SIZE	PACK SIZE
676565	White	10mm x 2.5m	10
676572	Gloss Black	10mm x 2.5m	10
	OTHER COLOURS P.O.A		

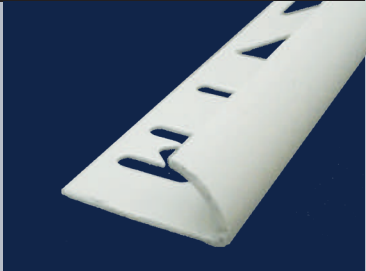

ROUND EDGE POWDERCOATED TILE TRIM			
ITEM No.	DESCRIPTION	SIZE	PACK SIZE
676566	White	12.5mm x 2.5m	10
676573	Gloss Black	12.5mm x 2.5m	10
	OTHER COLOURS P.O.A		



"Please Note: Anodised profiles are 2.5m long but sold as 2.4m due to anodising jig marks"

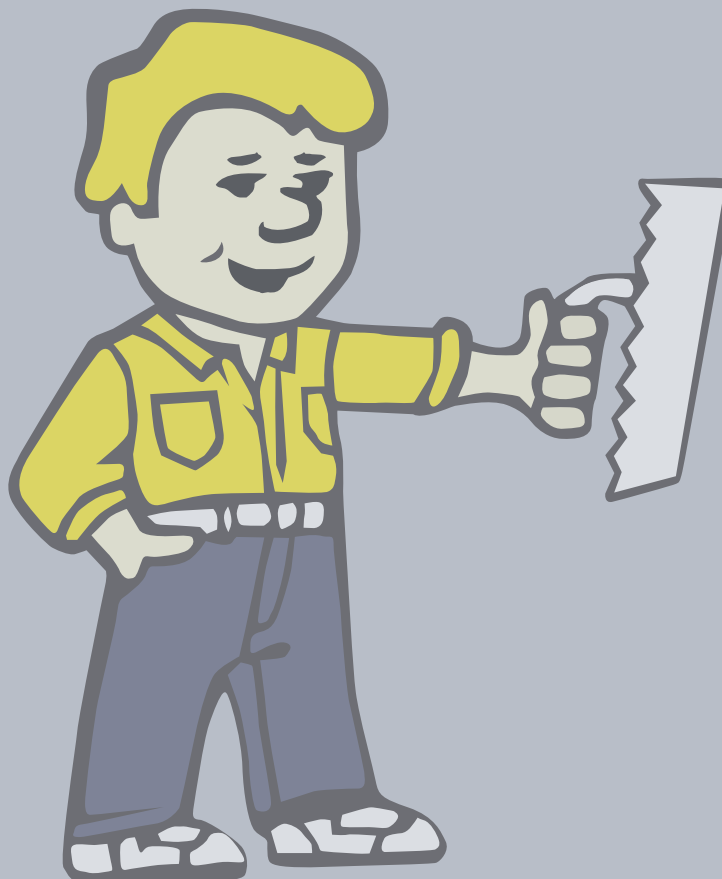

ALUMINIUM L-PROFILE TILE TRIM

ITEM No.	DESCRIPTION	SIZE	PACK SIZE
171450	Aluminium L-Profile	6mm x 2.5m	10
171452	Aluminium L-Profile	8mm x 2.5m	10
171460	Aluminium L-Profile	10mm x 2.5m	10
678280	Aluminium L-Profile	11mm x 2.5m	10
171463	Aluminium L-Profile	12.5mm x 2.5m	10
171465	Aluminium L-Profile	15mm x 2.5m	10
171448	Aluminium L-Profile	18mm x 2.5m	10
171449	Aluminium L-Profile	22mm x 2.5m	10
149614	Aluminium L-Profile	25mm x 2.5m	10

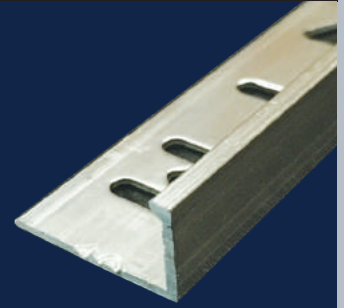

ANODISED L-PROFILE TILE TRIM

ITEM No.	DESCRIPTION	SIZE	PACK SIZE
171451	Matt (Brushed) Silver	6mm x 2.5m	10
171468	Bright Silver	6mm x 2.5m	10

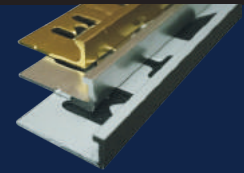

ANODISED L-PROFILE TILE TRIM

ITEM No.	DESCRIPTION	SIZE	PACK SIZE
171459	Matt (Brushed) Silver	8mm x 2.5m	10
677969	Champagne	8mm x 2.5m	10
678143	Bright Silver	8mm x 2.5m	10

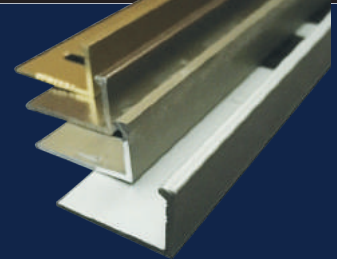

ANODISED L-PROFILE TILE TRIM

ITEM No.	DESCRIPTION	SIZE	PACK SIZE
171462	Matt (Brushed) Silver	10mm x 2.5m	10
676459	Bright Titanium	10mm x 2.5m	10
677970	Champagne	10mm x 2.5m	10
678144	Bright Silver	10mm x 2.5m	10

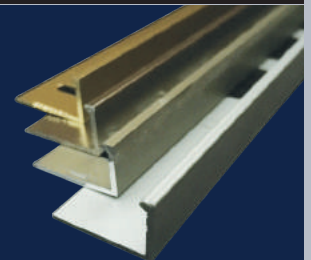

ANODISED L-PROFILE TILE TRIM

ITEM No.	DESCRIPTION	SIZE	PACK SIZE
676463	Bright Titanium	11mm x 2.5m	10
678175	Bright Silver	11mm x 2.5m	10
678176	Matt (Brushed) Silver	11mm x 2.5m	10

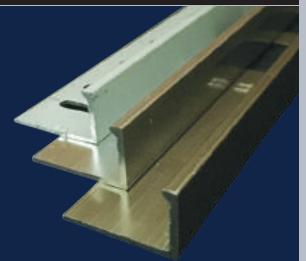

ANODISED L-PROFILE TILE TRIM

ITEM No.	DESCRIPTION	SIZE	PACK SIZE
171464	Matt (Brushed) Silver	12mm x 2.5m	10
676465	Bright Titanium	12.5mm x 2.5m	10
677971	Champagne	12mm x 2.5m	10
678145	Bright Silver	12mm x 2.5m	10

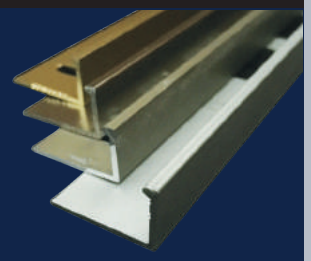

"Please Note: Anodised profiles are 2.5m long but sold as 2.4m due to anodising jig marks"



ANODISED L-PROFILE TILE TRIM

ITEM No.	DESCRIPTION	SIZE	PACK SIZE
677831	Matt (Brushed) Silver	15mm x 2.5m	10
677972	Champagne	15mm x 2.5m	10
677869	Bright Silver	15mm x 2.5m	10

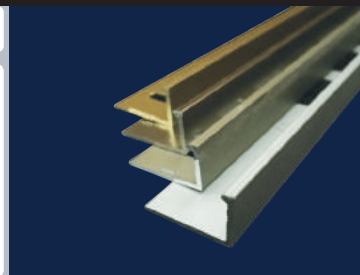

ANODISED L-PROFILE TILE TRIM

ITEM No.	DESCRIPTION	SIZE	PACK SIZE
677957	Matt (Brushed) Silver	18mm x 2.5m	10
677973	Champagne	18mm x 2.5m	10
678056	Bright Silver	18mm x 2.5m	10

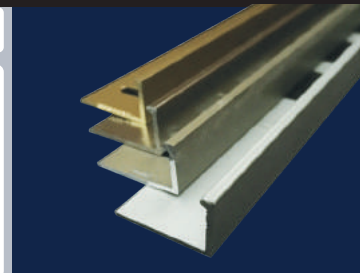

ANODISED L-PROFILE TILE TRIM

ITEM No.	DESCRIPTION	SIZE	PACK SIZE
677952	Matt (Brushed) Silver	22mm x 2.5m	10
678091	Bright Silver	22mm x 2.5m	10

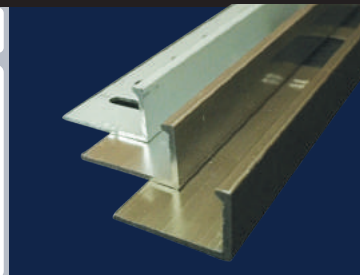

ALUMINIUM L-PROFILE TILE TRIM

ITEM No.	DESCRIPTION	SIZE	PACK SIZE
176037	Aluminium L-Profile	8mm x 3m	10
173852	Aluminium L-Profile	10mm x 3m	10
176040	Aluminium L-Profile	12mm x 3m	10
186529	Aluminium L-Profile	15mm x 3m	10

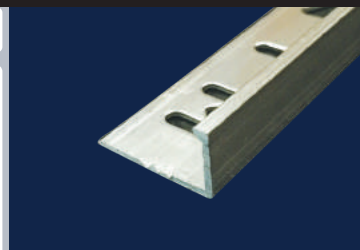

BRIGHT SILVER L-PROFILE TILE TRIM

ITEM No.	DESCRIPTION	SIZE	PACK SIZE
675008	Bright Silver L-Profile	8mm x 3m	10
675001	Bright Silver L-Profile	10mm x 3m	10
675003	Bright Silver L-Profile	12mm x 3m	10
675043	Bright Silver L-Profile	15mm x 3m	10



MATT (BRUSHED) SILVER L-PROFILE TILE TRIM

ITEM No.	DESCRIPTION	SIZE	PACK SIZE
695272	Matt (Brushed) Silver	10mm x 3m	10
695364	Matt (Brushed) Silver	12mm x 3m	10
678141	Matt (Brushed) Silver	15mm x 3m	10



"Please Note: Anodised profiles are 2.5m long but sold as 2.4m due to anodising jig marks"



POWDERCOATED L-PROFILE TILE TRIM

ITEM No.	DESCRIPTION	SIZE	PACK SIZE
676461	White	6mm x 2.5m	10
676468	Gloss Black	6mm x 2.5m	10
OTHER COLOURS P.O.A			



POWDERCOATED L-PROFILE TILE TRIM

ITEM No.	DESCRIPTION	SIZE	PACK SIZE
676462	White	8mm x 2.5m	10
676469	Gloss Black	8mm x 2.5m	10
676473	Matt Black	8mm x 2.5m	10
OTHER COLOURS P.O.A			



POWDERCOATED L-PROFILE TILE TRIM

ITEM No.	DESCRIPTION	SIZE	PACK SIZE
676457	White	10mm x 2.5m	10
676470	Matt Black	10mm x 2.5m	10
676474	Long White Cloud	10mm x 2.5m	10
676466	Gloss Black	10mm x 2.5m	10
OTHER COLOURS P.O.A			



POWDERCOATED L-PROFILE TILE TRIM

ITEM No.	DESCRIPTION	SIZE	PACK SIZE
695365	Matt Black	11mm x 2.5m	10
695366	Gloss Black	11mm x 2.5m	10
695410	Gloss White	11mm x 2.5m	10
OTHER COLOURS P.O.A			



POWDERCOATED L-PROFILE TILE TRIM

ITEM No.	DESCRIPTION	SIZE	PACK SIZE
676458	White	12mm x 2.5m	10
676467	Gloss Black	12mm x 2.5m	10
676471	Matt Black	12mm x 2.5m	10
677974	Long White Cloud	12mm x 2.5m	10
OTHER COLOURS P.O.A			



POWDERCOATED L-PROFILE TILE TRIM

ITEM No.	DESCRIPTION	SIZE	PACK SIZE
676464	White	15mm x 2.5m	10
676535	Gloss Black	15mm x 2.5m	10
OTHER COLOURS P.O.A			



"Please Note: Anodised profiles are 2.5m long but sold as 2.4m due to anodising jig marks"



Z-FLEX BENDABLE L-PROFILE TILE TRIM

ITEM No.	DESCRIPTION	SIZE	PACK SIZE
678111	Z-FLEX Matt (Brushed)Silver	4.5mm x 2.5m	10
675925	Z-FLEX Aluminium	6mm x 2.5m	10
675926	Z-FLEX Aluminium	8mm x 2.5m	10
675922	Z-FLEX Aluminium	10mm x 2.5m	10
675923	Z-FLEX Aluminium	12.5mm x 2.5m	10
675924	Z-FLEX Aluminium	15mm x 2.5m	10



ANODISED MOSAIC TRIM

ITEM No.	DESCRIPTION	SIZE	PACK SIZE
678114	L-Profile Bright Silver	4.5mm x 2.5m	10
678113	L-Profile Matt (Brushed)Silver	4.5mm x 2.5m	10
678099	L-Profile Aluminium	4.5mm x 2.5m	10
678110	Square Line Matt Silver	4.5mm x 2.5m	10
678109	Square Line Bright Silver	4.5mm x 2.5m	10

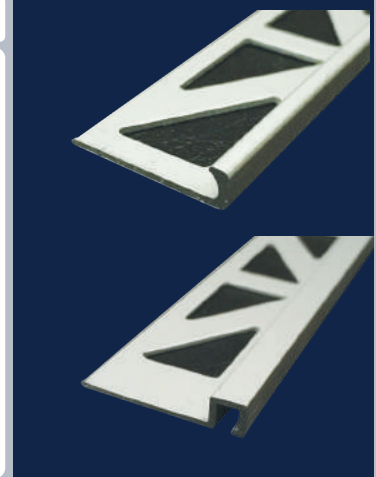

ALL OTHER COLOURS P.Q A

"Please Note: Anodised profiles are 2.5m long but sold as 2.4m due to anodising jig marks"





TILE TRIMS LISTELLO BORDERS

CONTINUOUS PENCIL LISTELLO

ITEM No.	DESCRIPTION	SIZE	PACK SIZE
167016	Listello Aluminium	10mm x 2.5m	10
169979	Matt (Brushed) Silver	10mm x 2.5m	10
170280	Bright Silver	10mm x 2.5m	10
676364	White	10mm x 2.5m	1
676373	Gloss Black	10mm x 2.5m	1
	OTHER COLOURS P.O.A		

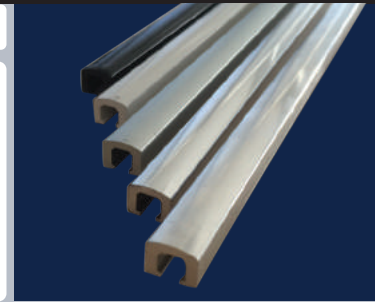

WIDE CONTINUOUS LISTELLO

ITEM No.	DESCRIPTION	SIZE	PACK SIZE
676422	Matt (Brushed) Silver	18mm x 2.5m	10
170283	Bright Silver	18mm x 2.5m	10
	OTHER COLOURS P.O.A		

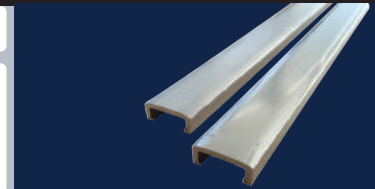

TILE TRIMS EXPANSION JOINT SYSTEM

EXPANSION JOINT - HEAVY DUTY - Aluminium

ITEM No.	DESCRIPTION	SIZE	PACK SIZE
677344	Grey	8mm x 2.5m	10
677342	Grey	10mm x 2.5m	10
677878	Black	10mm x 2.5m	10
677343	Grey	12.5mm x 2.5m	10
677345	Black	12.5mm x 2.5m	10

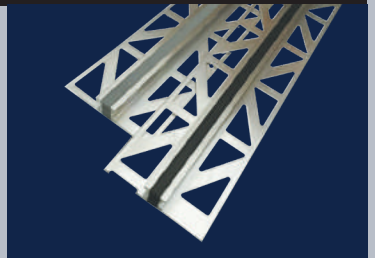

TILE TRIMS STAINLESS STEEL AND BRASS

STAINLESS STEEL L-PROFILE TILE TRIM

ITEM No.	DESCRIPTION	SIZE	PACK SIZE
676824	Stainless Steel L-Profile	8mm x 2.5m	5
676817	Stainless Steel L-Profile	10mm x 2.5m	5
676819	Stainless Steel L-Profile	12mm x 2.5m	5
678084	Stainless Steel L-Profile	15mm x 2.5m	5



BRASS L-PROFILE TILE TRIM

ITEM No.	DESCRIPTION	SIZE	PACK SIZE
675746	Brass L-Profile	8mm x 2.5m	5
677820	Brass L-Profile	10mm x 2.5m	5
675727	Brass L-Profile	12.5mm x 2.5m	5
675730	Brass L-Profile	15mm x 2.5m	5
675733	Brass L-Profile	18.5mm x 2.5m	5



"Please Note: Anodised profiles are 2.5m long but sold as 2.4m due to anodising jig marks"



GROOVED BEVEL STEP TRANSITION

ITEM No.	DESCRIPTION	SIZE	PACK SIZE
136958	Aluminium	8mm x 2.5m	5
136956	Aluminium	10mm x 2.5m	5

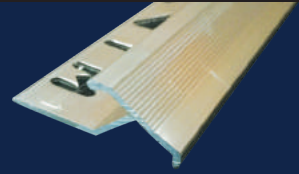

ANODISED DURATRANS STEP TRANSITION

ITEM No.	DESCRIPTION	SIZE	PACK SIZE
695271	Matt (Brushed) Silver	12.5mm x 2.5m	10
695270	Matt (Brushed) Silver	15mm x 2.5m	10
677986	Matt (Brushed) Silver	20mm x 2.5m	10

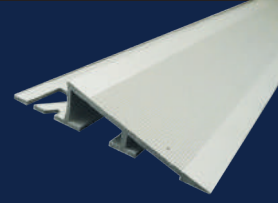

DURASTEP - Aluminium

ITEM No.	DESCRIPTION	SIZE	PACK SIZE
675901	Black Insert	35mm x 2.5m	10

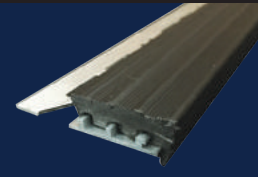

ANODISED FLORENTOSTEP

ITEM No.	DESCRIPTION	SIZE	PACK SIZE
677959	Matt (Brushed) Silver	11mm x 2.5m	10
677960	Matt (Brushed) Silver	14mm x 2.5m	10



ANODISED SQUARELINE

ITEM No.	DESCRIPTION	SIZE	PACK SIZE
677962	Matt (Brushed) Silver	9mm x 2.5m	1
677963	Matt (Brushed) Silver	11mm x 2.5m	1
677964	Matt (Brushed) Silver	13mm x 2.5m	1
677978	Bright Silver	9mm x 2.5m	1
677979	Bright Silver	11mm x 2.5m	1
677980	Bright Silver	13mm x 2.5m	1



ANODISED SQUARELINE CORNERS

ITEM No.	DESCRIPTION	SIZE	PACK SIZE
677965	Matt (Brushed) Silver Pair	9mm	1 Pair
677966	Matt (Brushed) Silver Pair	11mm	1 Pair
677967	Matt (Brushed) Silver Pair	13mm	1 Pair
677981	Bright Silver Pair	9mm	1 Pair
677982	Bright Silver Pair	11mm	1 Pair
677983	Bright Silver Pair	13mm	1 Pair

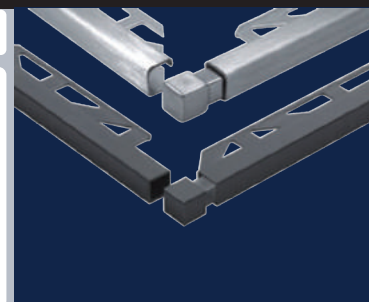

"Please Note: Anodised profiles are 2.5m long but sold as 2.4m due to anodising jig marks"



ROUND EDGE DESIGNER PVC TILE TRIM			
ITEM No.	DESCRIPTION	SIZE	PACK SIZE
677277	Gloss White	6mm x 2.5m	10
677298	Gloss White	8mm x 2.5m	10
667315	Gloss White	10mm x 2.5m	10
OTHER COLOURS P.O.A			





"Please Note: Anodised profiles are 2.5m long but sold as 2.4m due to anodising jig marks"













TILE CUTTERS AND SCRIBER - Great for Scribing and Breaking Tiles

ITEM No.	DESCRIPTION	PACK SIZE	
677040	Mosaic Cutter <i>Ideal for cutting glass mosaics and tiles.</i>	10	 

TILE NIPPERS - For Nibbling Away Edges of Tiles

ITEM No.	DESCRIPTION	PACK SIZE	
677037	8" (200mm) Tradesman Nippers <i>A straight cut nipper to trim and shape all types of ceramic tiles including porcelain.</i>	10	 
677038	Parrot Beak Nippers <i>Cuts small shapes to any type of ceramic tile. Cuts larger holes from the middle of the tile.</i>	10	 
677042	GT Professional Nippers <i>Offset jaws for accurate cutting of all kinds of tiles including porcelain.</i>	10	 
678088	GT Curved Blade Nippers <i>Curved jaw nipper to make it easier to make curved shapes in ceramic tiles.</i>	10	 





SUCTION CUPS

ITEM No.	DESCRIPTION	PACK SIZE	
678123	Single Suction Cup - Aluminium <i>For maneuvering non porous, smooth tiles, marble, granite and glass during installation.</i>	1	
678124	Double Suction Cup - Aluminium <i>For maneuvering non porous, smooth tiles, marble, granite and glass during installation.</i>	1	
676783	Siri Textured Surface Suction Cup <i>One handed operation suction cup lifter for textured & smooth tile alike.</i>	1	
676784	Siri Textured Surface Inserts for #676783 Sold as part of 676783	1	
TILE SPACE REMOVERS - Makes Removing Spacers Easy			
ITEM No.	DESCRIPTION	PACK SIZE	
676899	Tile Spacer Remover <i>Easy to use tile spacer removal tool.</i>	1	





TILE GROUT REMOVERS - For Smoothing Tile Edges

ITEM No.	DESCRIPTION	PACK SIZE	
676915	Professional Grout Rake <i>For the efficient removal of old grout.</i>	1	
676916	Blades(2) for Professional Grout Rake # 676915	1	



RUBBER MALLETS

ITEM No.	DESCRIPTION	PACK SIZE	
677014	White Non Marking Rubber Mallet <i>Gently tap down tiles to ensure a flat and even bed.</i>	1	







FLOOR SCRAPERS

ITEM No.	DESCRIPTION	PACK SIZE	
678126	Floor Scraper 1300mm x 150mm <i>For removal of old floor tiles.</i>	1	 

WHITE RUBBING STONE

ITEM No.	DESCRIPTION	PACK SIZE	
676937	Rubbing Stone (White) 60 Coarse <i>Smooth rough edges on freshly cut tile.</i>	10	 

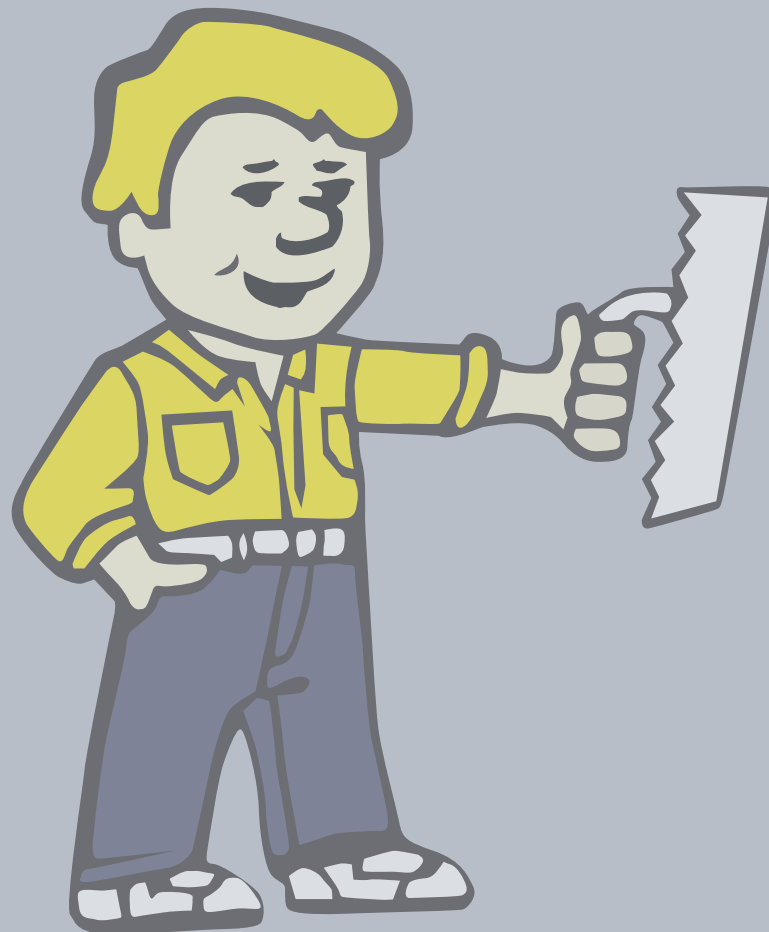



TILE AND GLASS MARKERS - Won't Wash Off Tiles

ITEM No.	DESCRIPTION	PACK SIZE	
677023	Tile & Glass Markers Black (Pkt of 12)	1	
677027	Tile & Glass Markers White (PKt of 12)	1	
<i>Use to accurately mark cut lines on tile and stone surfaces.</i>			

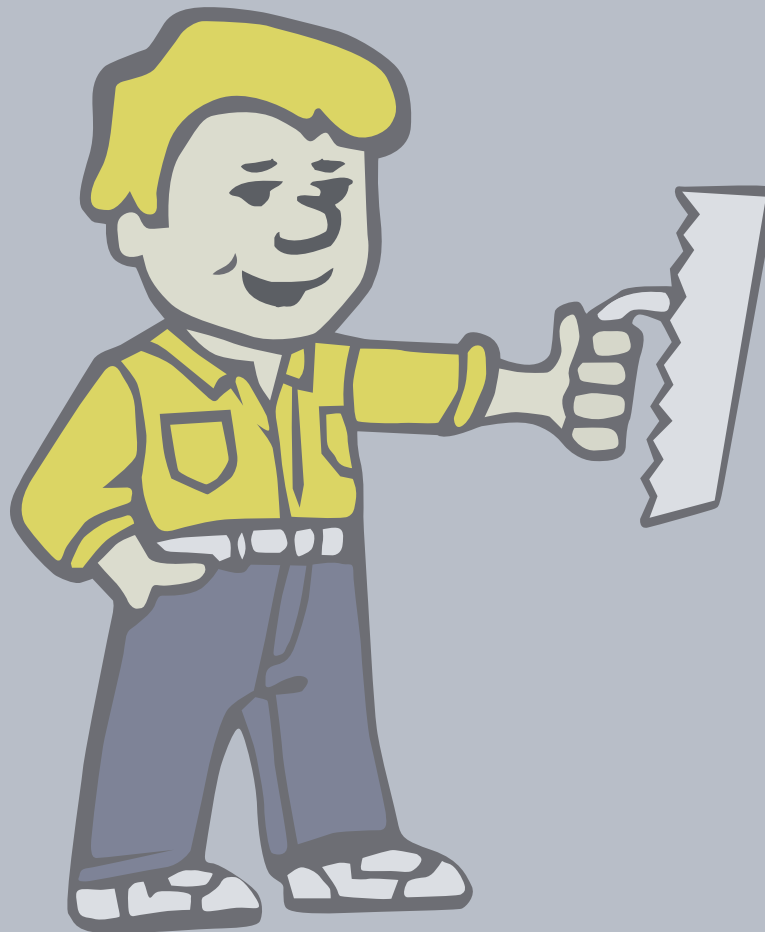

















TILE FILES

ITEM No.	DESCRIPTION	PACK SIZE	
676936	1/2 Round Tile File <i>Smooth rough tile edges.</i>	10	

TILE TRIM MITRE BOXES

ITEM No.	DESCRIPTION	PACK SIZE	
677050	Professional Wood & Metal Mitre Box <i>Ideal for aluminium trim.</i>	10	





KNEE PADS			
ITEM No.	DESCRIPTION	PACK SIZE	
678292	Crain Professional Comfort Knee Pad <i>Wide Velcro straps/non pinch. Extra thick padding.</i>	10	 
676904	Safe+Pro 2 Ply Knee pads <i>Flexible knee enables easier movement. The flexibility allows for comfort. The knee pads are totally rebuildable with replacement straps, buttons and inserts.</i>	12	 
676905	Knee Pad Straps for # 676904 - Pack of 4	1	 
676906	Knee Pad Buttons for #676904 - Set of 8	1	 
676907	Knee Pad Insert for #676904	2	 
678172	Professional Hard Shell Kneepad <i>These knee pads have a plastic hard cap for protection and can be used for sliding and swivelling on hard surfaces.</i>	2	 
678173	Neoprene Kneepad <i>Protects your knees whilst working on surfaces including tile, wood, carpet & vinyl.</i>	2	 





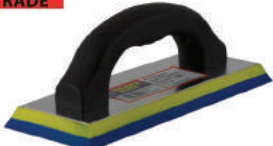

TRADE CAULKING GUNS

ITEM No.	DESCRIPTION	PACK SIZE	
678125	Trade Caulking Gun <i>Gun is designed for trade professionals caulking out large volumes daily.</i>	1	





RECTANGLE GROUT FLOATS

ITEM No.	DESCRIPTION	PACK SIZE	
676989	D-I-Yer Foam Rubber <i>Ideal for small tile installation jobs or repairs.</i>	10	
676990	Tradesman Soft Rubber <i>Natural sponge rubber pad makes this float easy to use. Soft rubber for basic grout.</i>	10	
676992	Professional Hard Rubber (Epoxy) <i>Natural sponge rubber pad makes this float easy to use. Hard rubber for epoxy grout.</i>	10	



GUM RUBBER GROUT FLOATS - For Extra Smoothing

ITEM No.	DESCRIPTION	PACK SIZE	
677002	Professional Standard Gum Float <i>Ensures a smooth application while forcing grout into joints.</i>	10	 
677003	Professional X-Large (16") <i>Ensures a smooth application while forcing grout into joints.</i>	10	 

POINTED GROUT FLOATS - Best for Getting in Corners

ITEM No.	DESCRIPTION	PACK SIZE	
676988	Professional Jap Style <i>Pointed edge for hard to reach places.</i>	10	 
677008	Professional Gum Rubber <i>Pointed edge for hard to reach places.</i>	10	 

CLOTH PRODUCTS

ITEM No.	DESCRIPTION	PACK SIZE	
678297	Microfibre Cloth Blue (Pack of 10) <i>The microfibre cloth eliminates the need for harsh chemicals & because you clean less often, you use less water.</i>	1	 









TILE SPONGES - Ideal for Cleaning Tiles

ITEM No.	DESCRIPTION	PACK SIZE	
676910	The Brick 200 x 100 x 75mm <i>Used to clean as you go for removing grout to finish quickly and cleanly.</i>	20	 
678130	Hydra Trade Sponge 310 x 210 x 40 <i>A highly absorbent sponge of the highest quality for cleaning tiles after grouting.</i>	10	 
678077	Hydra Sponge Round Edge 195 x 135 x 50 <i>Rounded edges to prevent "dissing out" or marring of grout.</i>	10	 
678078	Grout Haze Sponge Square Edge 160 x 110 x 48 <i>Ideal for cleaning tiled and slate areas after grouting.</i>	10	 
678079	Professional Grout Sponge Handle for #678070	10	 
678080	Professional Grout Clean up Sponge - Cut	10	 
678082	Professional Clean Cut Sponge & Handle Kit	10	 
678171	Grout Sponge with Handle	10	 







TILE SPONGES - Continued			
ITEM No.	DESCRIPTION	PACK SIZE	
678296	Thick Line Hand Bug (3 pads and handle) <i>For removal of stubborn grout & adhesive residue from tiled surfaces. 1 x Fine Pad, 1 x Medium Pad, 1 x Coarse Pad</i>	1	 
678294	Blue Thick Line Pads (Pack of 10) <i>For removal of stubborn grout & adhesive residue from tiles surfaces. 250mm x 115mm. Fine pad.</i>	1	 
678293	White Thick Line Pads(Pack of 10) <i>For removal of stubborn grout & adhesive residue from tiles surfaces. 250mm x 115mm. Medium Pad.</i>	1	 
678298	Gala Rub Out Sponge 180 x 85 x 40 <i>Experience the incredible Gala Rub Out cleaning power.</i>	1	 







TRADESMAN GROUT SQUEEGEES - Wood / Rubber

ITEM No.	DESCRIPTION	PACK SIZE	
676994	6" 150mm Grout Squeegee <i>For use on floor and wall tiles.</i>	50	 
676996	9" 230mm Grout Squeegee <i>For use on floor and wall tiles.</i>	50	 
676999	12" 300mm Grout Squeegee <i>For use on floor and wall tiles.</i>	50	 

PLASTIC ADHESIVE SPREADERS - Ideal For Small Jobs . Made in New Zealand

ITEM No.	DESCRIPTION	PACK SIZE	
676920	4mm V-Notch Plastic Spreader <i>Perfect for small DIY ceramic tile applications.</i>	10	 
676922	4mm Square Notch Plastic Spreader <i>Economy notched adhesive spreader.</i>	10	 
676924	6mm Square Notch Plastic Spreader <i>Economy notched adhesive spreader.</i>	10	 

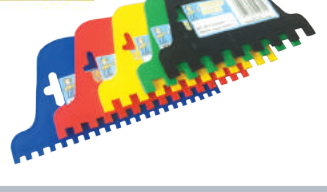
PLASTIC ADHESIVE SPREADERS - Continued

ITEM No.	DESCRIPTION	PACK SIZE	
676926	8mm Square Notch Plastic Spreader <i>Economy notched adhesive spreader.</i>	10	 
676928	10mm Square Notch Plastic Spreader <i>Economy notched adhesive spreader.</i>	10	 
676930	12mm Square Notch Plastic Spreader <i>Economy notched adhesive spreader.</i>	10	 

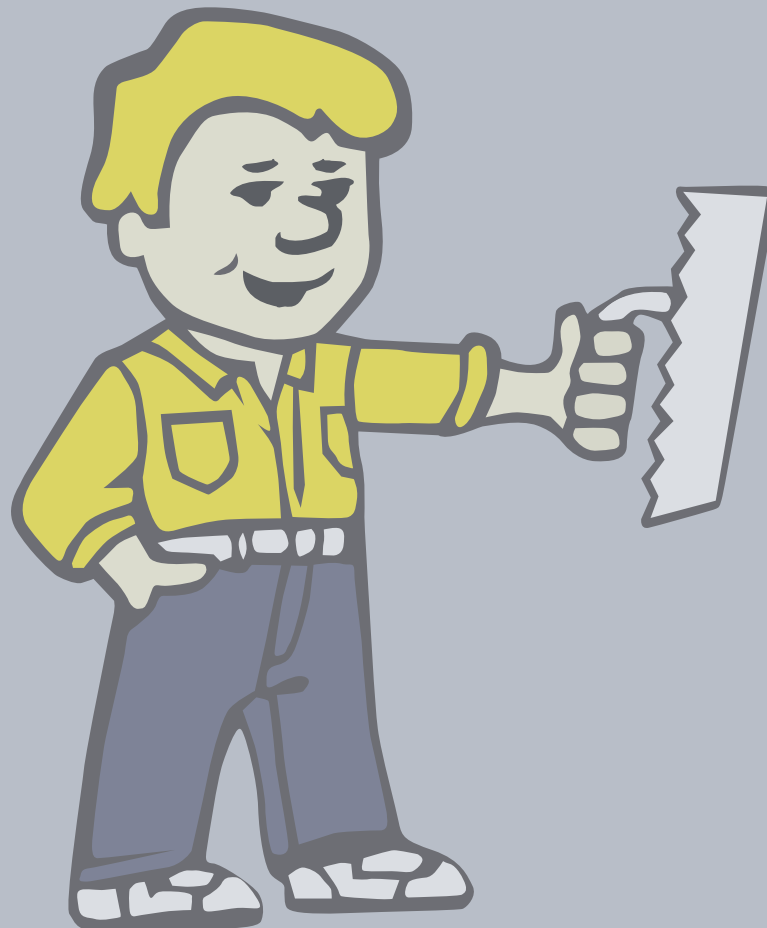









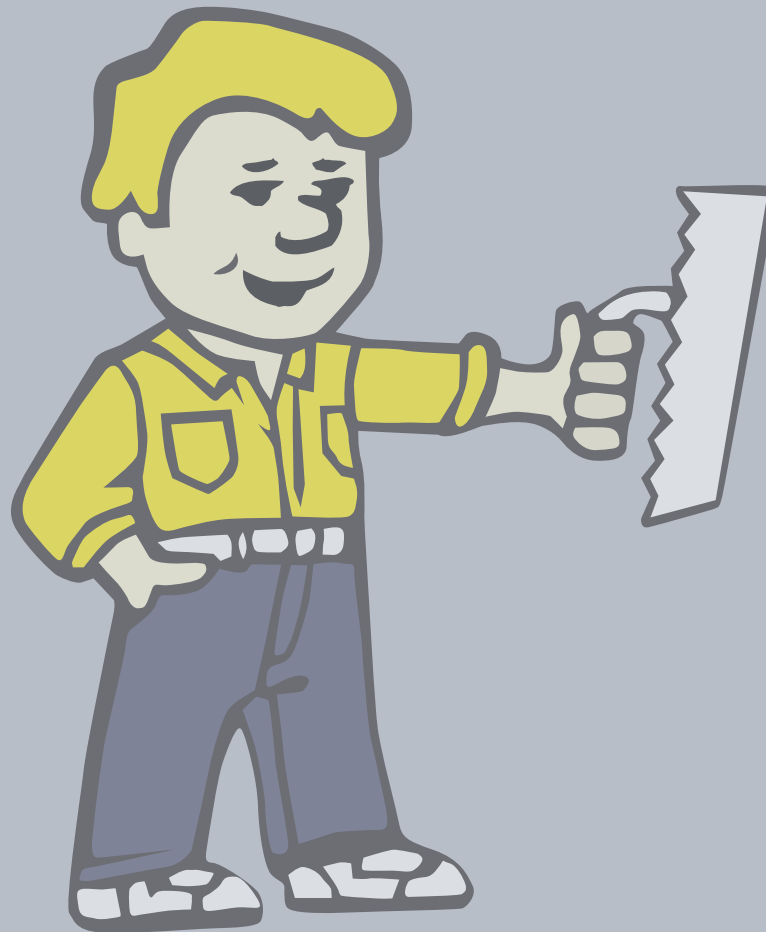



GRIP-MATE STAINLESS STEEL TROWELS

ITEM No.	DESCRIPTION	PACK SIZE
676980	4mm Square Notch Grip-Mate Trowel	12
676981	6mm Square Notch Grip-Mate Trowel	12
676982	8mm Square Notch Grip-Mate Trowel	12
676983	10mm Square Notch Grip-Mate Trowel	12
676984	12mm Square Notch Grip-Mate Trowel	12
678081	15mm Square Notch Grip-Mate Trowel	12



Designed to allow easy application of tile adhesive. Stainless Steel Blade.







D-I-Y POWDERCOATED ADHESIVE TROWELS - Ideal For Small Jobs			
ITEM No.	DESCRIPTION	PACK SIZE	
676939	4mm Square Notch Adhesive Trowel <i>Good DIY trowel for ceramic tile jobs.</i>	6	 
676940	6mm Square Notch Adhesive Trowel <i>Good DIY trowel for ceramic tile jobs.</i>	6	 
676941	8mm Square Notch Adhesive Trowel <i>Good DIY trowel for ceramic tile jobs.</i>	6	 
676942	10mm Square Notch Adhesive Trowel <i>Good DIY trowel for ceramic tile jobs.</i>	6	 
676943	12mm Square Notch Adhesive Trowel <i>Good DIY trowel for ceramic tile jobs.</i>	6	 





GAUGING TROWELS - Soft Grip Handle

ITEM No.	DESCRIPTION	PACK SIZE	
676985	7" (175mm) Gauging Trowel <i>For applying a solid coverage of adhesive when fixing wall tiles.</i>	6	 
676986	9" (230mm) Gauging Trowel <i>For applying a solid coverage of adhesive when fixing wall tiles.</i>	6	 



STAINLESS STEEL SPLASH TROWELS - Soft Grip Handle

ITEM No.	DESCRIPTION	PACK SIZE	
678153	Stainless Steel Splash Trowels 140x107x85mm <i>Used for mixing and applying adhesive.</i>	6	 
678154	Stainless Steel Splash Trowels 200x126x96mm <i>Used for mixing and applying adhesive</i>	6	 

STAINLESS STEEL SCRAPER









ITEM No.	DESCRIPTION	PACK SIZE	
678164	Stainless Steel Paint Scraper 10mm Notch 100mm x 10mm	10	 

TILE AND SLATE CEMENT BOARD NAILS



ITEM No.	DESCRIPTION	PACK SIZE	
678178	Board Nails 25mm x 2.8mm 500gms <i>Designed for fixing cement sheets and plaster board to timber substrates.</i>	36	 



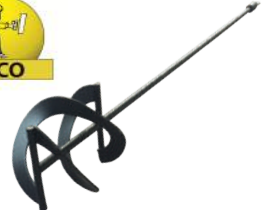

ADHESIVE MIXERS - All Types of Mixing

ITEM No.	DESCRIPTION	PACK SIZE	
677142	Spiral Mixer for #678281 Mixer M14 <i>For mixing small amounts of thinset, mortar, cement, plaster & similar products.</i>	1	 
677145	Mix-Mate Large Box Mixer <i>This mixing paddle minimises the introduction of air into the mixture. 140mm x 710mm</i>	6	 
678320	Large Box Mixer M14 Thread for Electric Mixer # 678281 <i>This mixing paddle minimises the introduction of air into the mixture. 140mm x 580mm</i>	6	 
677146	Mini Mix Small Spiral Mixer <i>Professional tool for mixing paint, thinset and other materials. 60mm x 450mm</i>	6	 
677147	Mix-Mate Small Spiral Mixer <i>Designed for the fast and effective mixing of all types of setting & grouting substances. 120mm x 605mm</i>	6	 

ELECTRIC HAND MIXER

ITEM No.	DESCRIPTION	PACK SIZE	
678281	Electric Hand Mixer. Powerful 1600W motor. <i>Designed to mix thick/dense materials.</i>	330	 

HOBBS

ITEM No.	DESCRIPTION	PACK SIZE	
678095	Shower Hob - 600mm x 75mm x 65mm <i>Used to contain water withing a shower enclosure.</i>	36	 



ROMA TRADE CUTTERS - Dual Rail ECO Wall Tile Cutters

ITEM No.	DESCRIPTION	PACK SIZE	
677054	ROMA Cutter 430mm Cut <i>Dual rail, cuts wall and floor tiles upto 430mm</i>	3	
677055	ROMA Cutter 500mm Cut <i>Dual rail, cuts wall & floor tiles upto 500mm.</i>	3	

VENEZIA TRADE CUTTER - Dual Rail Trade Tile Cutters



ITEM No.	DESCRIPTION	PACK SIZE	
677062	Venezia Cutter 330mm Cut <i>Dual rail, cuts wall & floor tiles upto 330mm</i>	3	
677064	Breaker Bar for #677062	1	

CUT-MATE PRO CUTTERS - Lineal Bearing , Dual Rail Tradesman Tile Cutters

ITEM No.	DESCRIPTION	PACK SIZE	
695369	Cut-Mate Cutter 400mm Cut <i>Dual rail, lineal bearing, reinforced steel base, adjustable stop guide. Cuts wall and floor tiles upto 400mm</i>	3	
677058	Cut-Mate Cutter 500mm Cut <i>Dual rail, cuts wall & floor tiles upto 500mm</i>	3	
677065	Breaker Bar for #677058	1	
677059	Cut-Mate Cutter 600mm Cut <i>Dual rail, cuts wall & floor tiles upto 600mm</i>	3	
677065	Breaker Bar for #677059	1	



HEAVY DUTY TILE CUTTER - Dual Rail Lineal Bearing intergrated cutting guide

ITEM No.	DESCRIPTION	PACK SIZE	
678115	Tile Cutter 600mm Cut with case <i>Heavy duty dual rail, cuts wall and floor tile upto 600mm. Comes with case.</i>	1	
678118	Tile Cutter 800mm Cut with case <i>Heavy duty dual rail, cuts wall and floor tile upto 800mm. Comes with case.</i>	1	
678116	Tile Cutter 1000 mm Cut no case <i>Heavy duty dual rail, cuts wall and floor tile upto 1000mm. (No Case)</i>	1	

REPLACEMENT WHEELS FOR MANUAL CUTTERS







ITEM No.	DESCRIPTION	PACK SIZE	
678117	8mm Replacement Wheel for Cutter Will fit 678115, 678118 and 678116	1	
677079	Small Replacement Wheel	1	
677080	Large Replacement Wheel Will fit # 677054, 677055, 677059 & 677062	1	

SIGMA PRO TILE CUTTERS - Mono Rail - c /w 45 Degree Extension Arm

ITEM No.	PART No.	DESCRIPTION	PACK SIZE	
677836	SG-3B4	670mm Cut, 1000Kg BP <i>Manual Tile Cutter for straight & any angle repetitive cuttings on all types of tiles.</i>	2	
677837	SG-3C2	770mm Cut, 1000Kg BP <i>Manual Tile Cutter for straight & any angle repetitive cuttings on all types of tiles.</i>	2	





SIGMA PRO TILE CUTTERS - Continued

ITEM No.	PART No.	DESCRIPTION	PACK SIZE	
677819	SG-3D2	950mm Cut, 1000Kg BP <i>Manual tile cutter for straight & any angle repetitive cutting on all types of tiles.</i>	1	
677936	SG-3E2K	1280mm Cut, 1000Kg BP <i>Manual tile cutter for straight & any angle repetitive cutting on all types of tiles.</i>	1	
678104	SG-43	Suit Case for 3B4 - 677836 and 3C2 - 677837. <i>Case with wheels</i>	1	
678151	SG-2G	Sigma 370mm Cutter with 45 Degree <i>It features a rapid positioning button for angle cuts from 0-45°</i>	1	
678152	SG-7A	Sigma 330mm Cutter <i>This cutter is able to rip cut any tile up to 330mm and diagonal cut any tile up to 240mm.</i>	1	
676807	SG-5A	Sigma 510mm Cutter With 45 Degree <i>It features a rapid positioning button for angle cuts from 0-45°</i>	1	



SIGMA KERA - CUT - For Large Format Tiles or Laminates





ITEM No.	PART No.	DESCRIPTION	PACK SIZE	
678128	SG-8C2	1510mm cut length <i>For large format tiles or laminates.</i>	1	
678121	SG-8E2	3010mm cut length <i>For large format tiles or laminates.</i>	1	
678131	SG-38C	Sigma Kera -Cut Sliding Guide 1510mm	1	

SIGMA ACCESSORIES & SPARE PARTS

ITEM No.	PART No.	DESCRIPTION	PACK SIZE
676800	SG-10433	Sigma No Mark Protection for Handle 24EK	1
678075	SG-1079104	Sigma nut M8 x 20 for Clamping Lever	1
678074	SG-108621	Sigma Clamping Knob Lever M8 x 35	1
676971	SG-14A	Sigma Wheel & Pin Spindle 12mm	1
676972	SG-14C	Sigma Klick Klock Wheel 16mm	1
676813	SG-14K	Sigma 19mm Scoring Wheel (Kera Cut)	1
676794	SG-19	Sigma Swivel Support Square 0-45 (for 7A)	1
676795	SG19A	Sigma Sliding Square (5A,5B,4A,4B)	1
678073	SG-19D	Sigma Sliding Square 260mm 3EK	1
676796	SG-20B	Sigma Bar Adjust Nut & Bolt	1
676798	SG-24A	Sigma Handle & Wheel 10mm (3C2, 3D2)	1
676797	SG-24E	Sigma Handle & Wheel 8mm (3B4)	1
676799	SG-24M10	Sigma Max Push Handle 10mm	1
676801	SG-38	Sigma Central Bar 50cm (5)	1
678802	SG-38A	Sigma Central Bar 51cm (5A)	1
676803	SG-38C	Sigma Sliding Guide 151cm	1
676811	SG-90	Sigma Diagonal Arm (4A) 75cm	1
676812	SG-90B	Sigma Diagonal Arm (5A) 51cm	1
677814	SG-90C	Sigma Diagonal Arm (5B) 62cm	1
678087	SG-90LB	Sigma Diagonal Arm (3B) 67cm	1
678072	SG-90LC	Sigma Diagonal Arm (3C) 77cm	1
678071	SG-90LD	Sigma Diagonal Arm (3D) 95cm + 3EK	1
676815	SG-92	Sigma Diagonal Arm Clamping Knob M10 x 25	1



TILER'S MATE DIAMOND SAWS

ITEM No.	DESCRIPTION	PACK SIZE	
678155	Bench Wet Saw 180mm	1	
678177	Porcelain Blade for Bench Wet Saw 180mm x 22.2mm	1	
ITEM No.	DESCRIPTION	PACK SIZE	
678055	800w Overhead Tile Saw <i>200mm Blade, 1hp, Max Depth 45mm Radial Arm with tilt. Max 600mm cut length.</i>	1	
ITEM No.	DESCRIPTION	PACK SIZE	
678096	1000w Overhead Tile Saw <i>250mm Blade, 1.5hp, Max Depth 60mm, Radial Arm with Tilt Cut 920mm. Max 920mm cut length.</i>	1	
ITEM No.	DESCRIPTION	PACK SIZE	
678107	1500w Overhead Tile Saw <i>250mm Blade, 2hp, Max Depth 60mm, Radial Arm with Tilt cut 1250mm. Max 1250mm cut length.</i>	1	



DIAMOND TOOLS

ITEM No.	DESCRIPTION	PACK SIZE
DCD0005-05	Dry Tile Bit 5mm x hex ** Standard (VB) (work/shank length= 32/35mm)	1
DCD0006-05	Dry Tile Bit 6mm x hex ** Standard (VB) (work/shank length = 32/35mm)	1
DCD0008-05	Dry Tile Bit 8mm x hex ** Standard (VB) (work/shank length = 40/40mm)	1
DCD0010-05	Dry Tile Bit 10mm x hex ** Standard (VB) (work/shank length = 40/40mm)	1
DCD0012-05	Dry Tile Bit 12mm x hex ** Standard (VB) (work/shank length = 40/40mm)	1



The VB (Vacuum Brazed) dry drill bits are designed to be used in conventional rotary drills. Can be used wet or dry. Fast Performance.

ITEM No.	DESCRIPTION	PACK SIZE
MDX-WAS-EC001	Water Swivel Economy (hex - P12.7) P12.7 tile	1



ITEM No.	DESCRIPTION	PACK SIZE
DCW0001-T100-TDG1	Tile Drill Pilot Guide with Suction cup	1
DCW0001-T100-TDK7	Tile Core Drill Kit (7pc) with case. 6mm, 8mm, 10mm & 13mm	1
DCD0001-0001	Dry Tile Core Drill Kit (6pc) with Case 5mm, 6mm, 7mm, 8mm, 10mm & 12mm	1



ITEM No.	DESCRIPTION	PACK SIZE
DCW0006-T100-P12	Tile Core Drill 6mm x 50 x P12.7 T100 Premium ***	1
DCW0008-T100-P12	Tile Core Drill 8mm x 50 x P12.7 T100 Premium ***	1
DCW0010-T100-P12	Tile Core Drill 10mm x 50 x P12.7 T100 Premium ***	1
DCW0013-T100-P12	Tile Core Drill 13mm x 50 x P12.7 T100 Premium ***	1
DCW0016-T100-P12	Tile Core Drill 16mm x 50 x P12.7 T100 Premium ***	1
DCW0020-T100-P12	Tile Core Drill 20mm x 50 x P12.7 T100 Premium ***	1
DCW0025-T100-P12	Tile Core Drill 25mm x 50 x P12.7 T100 Premium ***	1
DCW0028-T100-P12	Tile Core Drill 28mm x 50 x P12.7 T100 Premium ***	1
DCW0030-T100-P12	Tile Core Drill 30mm x 50 x P12.7 T100 Premium ***	1



T100 Tile Core Drill bits are designed for porcelain & ceramic tiles, granite, marble and stone. They feature a sintered diamond segment or ring and must be used wet, preferably in conjunction with the P12.7 water swivel.

DIAMOND TOOLS

ITEM No.	DESCRIPTION	PACK SIZE
DCW0032-T100-P12	Tile Core Drill 32mm x 50 x P12.7 T100 Premium ***	1
DCW0035-T100-P12	Tile Core Drill 35mm x 50 x P12.7 T100 Premium ***	1
DCW0038-T100-P12	Tile Core Drill 38mm x 50 x P12.7 T100 Premium ***	1
DCW0040-T100-P12	Tile Core Drill 40mm x 50 x P12.7 T100 Premium ***	1
DCW0045-T100-P12	Tile Core Drill 45mm x 50 x P12.7 T100 Premium ***	1
DCW0050-T100-P12	Tile Core Drill 50mm x 50 x P12.7 T100 Premium ***	1
DCW0062-T100-P12	Tile Core Drill 62mm x 50 x P12.7 T100 Premium ***	1
DCW0072-T100-P12	Tile Core Drill 72mm x 50 x P12.7 T100 Premium ***	1
DCW0082-T100-P12	Tile Core Drill 82mm x 50 x P12.7 T100 Premium ***	1
DCW0092-T100-P12	Tile Core Drill 92mm x 50 x P12.7 T100 Premium ***	1
DCW0102-T100-P12	Tile Dore Drill 102mm x 50 x P12.7 T100 Premium ***	1
DCW0115-T100-P12	Tile Core Drill 115mm x 50 x P12.7 T100 Premium ***	1
DCW0125-T100-P12	Tile Core Drill 125mm x 50 x P12.7 T100 Premium ***	1



T100 Tile Core Drill bits are designed for porcelain & ceramic tiles, granite, marble and stone. They feature a sintered diamond segment or ring and must be used wet, preferably in conjunction with the P12.7 water swivel.

ITEM No.	DESCRIPTION	PACK SIZE
DDS0105-TMA-C3R	Tile Master Blade 106 x 1.2 x 8 DCT Basic *	1
DDS0115-TMA-C3R	Tile Master Blade 115 x 1.4 x 8 DCT Basic *	1
DDS0125-TMA-C3R	Tile Master Blade 125 x 1.4 x 8 DCT Basic *	1





DIAMOND TOOLS		
ITEM No.	DESCRIPTION	PACK SIZE
DDS0080-TMY-C3R	Tile Mighty Blade 80 x 1.2 x 5 DCT Standard **	1
DDS0106-TMY-C3R	Tile Mighty Blade 106 x 1.4 x 8 DCT Standard **	1
DDS0115-TMY-C3R	Tile Mighty Blade 115 x 1.4 x 8 DCT Standard **	1
DDS0125-TMY-C3R	Tile Mighty Blade 125 x 1.2 x 8 DCT Standard **	1
DDS0180-TMY-C3R	Tile Mighty Blade 180 x 1.6 x 8 DCT Standard **	1
DDS0200-TMY-C3R	Tile Mighty Blade 200 x 1.6 x 8 DCT Standard **	1
DDS0230-TMY-C3R	Tile Mighty Blade 230 x 1.8 x 8 DCT Standard **	1
DDS0250-TMY-C3R	Tile Mighty Blade 250 x 1.6 x 9 DCT Standard **	1
DDS0300-TMY-C3R	Tile Mighty Blade 300 x 2.0 x 9 DCT Standard **	1
DDS0350-TMY-C3R	Tile Mighty Blade 350 x 2.0 x 9 DCT Standard **	1



ITEM No.	DESCRIPTION	PACK SIZE
DDS0105-040	Tile Victory Blade 105 x 1.4 x 10 Premium ***	1
DDS0115-040	Tile Victory Blade 115 x 1.4 x 10 Premium ***	1
DDS0125-040	Tile Victory Blade 125 x 1.4 x 10 Premium ***	1



ITEM No.	DESCRIPTION	PACK SIZE
DGC0100-020	Spiral Turbo Cup 100mm (100x5x5) Basic*	1
DGC0125-020	Spiral Turbo Cup 125mm (125x5x5) Basic*	1
DGC0180-020	Spiral Turbo Cup 180mm (180x5x5)Basic*	1

TS Turbo Spiral Cup Grinders are ideally suited for a medium to fine finish, ideal for coatings to go onto. Performance is fast. Ideal for concrete, thin & hard paint or glue.





DIAMOND TOOLS

ITEM No.	DESCRIPTION	PACK SIZE
MPTX-HOL-GDG100	Dust shroud 100mm (Grinding) Basic*	1
MPTX-HOL-GDG125	Dust shroud 125mm (Grinding) Basic*	1
MPTX-HOL-GDG180	Dust shroud 180mm (Grinding) Basic* Makita/Hitachi	1
MPTX-HOL-GDG180 PM-01	Dust shroud 180mm Composite Plastic Standard** Makita/Hitachi	1



ITEM No.	DESCRIPTION	PACK SIZE
DPW0100-PVA10-0060	Dry Polishing Wheel 100 x 16 #60 PVA *** Premium	1
DPW0100-PVA10-0120	Dry Polishing Wheel 100 x 16 #120 PVA*** Premium	1



ITEM No.	DESCRIPTION	PACK SIZE
MDX-AID-MASP2	Sharpening Block SP2 80 x 25 x 150	1
MDX-AID-MASP1	Sharpening Block SP1 160 x 30 x 320	1



ITEM No.	DESCRIPTION	PACK SIZE
DPH0900-FOAM2-0060	Diamond Hand Pad 90 x 55mm #60M Standard**	1
DPH0900-FOAM2-0100	Diamond Hand Pad 90 x 55mm #100M Standard**	1
DPH0900-FOAM2-0200	Diamond Hand Pad 90 x 55mm #200M Standard**	1
DPH0900-FOAM2-0400	Diamond Hand Pad 90 x 55mm #400M Standard**	1



ITEM No.	DESCRIPTION	PACK SIZE
DGC0100-TSBK08	Spiral Turbo Cup 100mm (100x5x5)Standard **	1
DGC0125-TSBL10	Spiral Turbo Cup 125mm (125x5x5)Standard **	1
DGC0180-TSBK12	Spiral Turbo Cup 180mm (180x5x5)Standard **	1

TS Turbo Spiral Cup grinders are ideally suited for a medium to fine finish, ideal for coatings to go onto. Performance is fast. Ideal for concrete, thin & hard paint or glue.

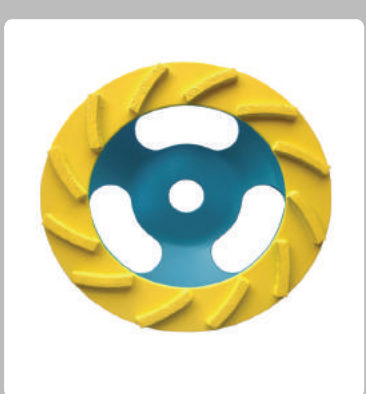



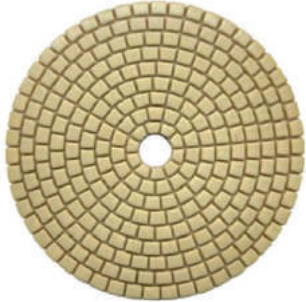

DIAMOND TOOLS

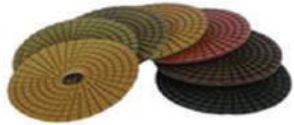
ITEM No.	DESCRIPTION	PACK SIZE	
DPV0100-DRY3-0050	Dry Polishing Pad 100mm #50 Premium ***	1	 <p><i>Dry Polishing pads are designed for polishing concrete, stone, granite, tiles and terrazzo. The white resin ensures that the pad does not mark any light coloured material. Velcro back.</i></p>
DPV0100-DRY3-0100	Dry Polishing Pad 100mm #100 Premium ***	1	
DPV0100-DRY3-0200	Dry Polishing Pad 100mm #200 Premium ***	1	
DPV0100-DRY3-0400	Dry Polishing Pad 100mm #400 Premium ***	1	
DPV0125-DRY3-0050	Dry Polishing Pad 125mm #50 Premium ***	1	
DPV0125-DRY3-0100	Dry Polishing Pad 125mm #100 Premium ***	1	
DPV0125-DRY3-0200	Dry Polishing Pad 125mm #200 Premium ***	1	
DPV0125-DRY3-0400	Dry Polishing Pad 125mm #400 Premium ***	1	

ITEM No.	DESCRIPTION	PACK SIZE	
DPV0100-DRY3-SET-7	Dry Polishing Pad 100mm Set of 7 Premium *** #50, #100, #200, #400, #800 #1500 & #3000	1	 <p><i>Backing pad for use with Dry Polishing pad.</i></p>

ITEM No.	DESCRIPTION	PACK SIZE	
DPX0100-MAP1-M14	Magic Pad Velcro 100mm x M14 Premium ***	1	
DPX0125-MAP1-M14	Magic Pad Velcro 125mm x M14 Premium ***	1	

ITEM No.	DESCRIPTION	PACK SIZE	
MPTX-HOL-GDGX01	Velcro Loop & Rubber Belt 640mm for Basic* Dust Shroud. <i>Cut to suit (suits all shrouds, 4", 5" & 7")</i>	1	

ITEM No.	DESCRIPTION	PACK SIZE	
ZSP-HOL-555004	Delux Dust Shroud Nylon replacement wear strip <i>For Standard and Premium Dust Shrouds</i>	1	



PREMIER RANGE - CROSS SPACERS

SMALL CROSS TILE SPACERS - 1.5mm - Ideal For Wall Tiles

ITEM No.	DESCRIPTION	PACK SIZE
676838	1.5mm Small Cross Spacers (100) Pkt	10
676840	1.5mm Small Cross Spacers (500) Pkt	10
676842	1.5mm Small Cross Spacers (1000) Pkt	10
676844	1.5mm Small Cross Spacers (2000) Bucket	10
676845	1.5mm Small Cross Spacers (4000) Bucket	6
676846	1.5mm Small Cross Spacers (25000) Made to Order	1



MEDIUM CROSS TILE SPACERS - 2mm - Ideal For Wall Tiles

ITEM No.	DESCRIPTION	PACK SIZE
677833	2mm Medium Cross Spacers (100) Pkt	10
677834	2mm Medium Cross Spacers (500) Pkt	10
677835	2mm Medium Cross Spacers (1000) Pkt	10
678308	2mm Medium Cross Spacers (4000) Bucket	10
676853	2mm Medium Cross Spacers (5000) Pkt	10



MEDIUM CROSS TILE SPACERS - 3mm - Ideal For Large Wall and Floor Tiles

ITEM No.	DESCRIPTION	PACK SIZE
676849	3mm Medium Cross Spacers (100) Pkt	10
676851	3mm Medium Cross Spacers (500) Pkt	10
676854	3mm Medium Cross Spacers (1000) Bucket	10
676856	3mm Medium Cross Spacers (1500) Bucket	6
676857	3mm Medium Cross Spacers (3000) Pkt	6
676858	3mm Medium Cross Spacers (5000) Pkt	4



LARGE CROSS TILE SPACERS - 5mm - Ideal For Floor Tiles

ITEM No.	DESCRIPTION	PACK SIZE
676861	5mm Large Cross Spacers (100) Pkt	10
676863	5mm Large Cross Spacers (250) Pkt	10
676864	5mm Large Cross Spacers (500) Pkt	10



EXTRA LARGE CROSS TILE SPACERS - 8mm - Ideal For Larger Floor Tiles

ITEM No.	DESCRIPTION	PACK SIZE
676868	8mm Extra Large Cross Spacers (100)	10
676870	8mm Extra Large Cross Spacers (500)	10



JUMBO CROSS TILE SPACERS - 10mm - Ideal For Larger Floor Tiles

ITEM No.	DESCRIPTION	PACK SIZE
676871	10mm Jumbo Cross Spacers (100) Pkt	10
676873	10mm Jumbo Cross Spacers (500) Pkt	10



**ECONOMY CROSS SPACERS****CROSS SPACERS - 1.5mm**

ITEM No.	DESCRIPTION	PACK SIZE
676839	1.5mm Small Economy Cross Spacers (100) Pkt	10
676841	1.5mm Small Economy Cross Spacers (500) Pkt	10
676843	1.5mm Small Economy Cross Spacers (1000) Pkt	10

**CROSS SPACERS - 2mm**

ITEM No.	DESCRIPTION	PACK SIZE
678000	2mm Medium Economy Cross Spacers (100) Pkt	10
678001	2mm Medium Economy Cross Spacers (500) Pkt	10
676848	2mm Medium Economy Cross Spacers (1000)Pkt	10

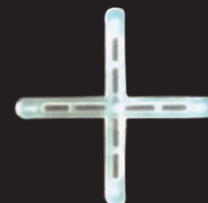
**CROSS SPACERS - 3mm**

ITEM No.	DESCRIPTION	PACK SIZE
676850	3mm Medium Economy Cross Spacers (100) Pkt	10
676852	3mm Medium Economy Cross Spacers (500) Pkt	10
676855	3mm Medium Economy Cross Spacers (1000)Pkt	10

**CROSS SPACERS - 5mm**

ITEM No.	DESCRIPTION	PACK SIZE
676862	5mm Large Economy Cross Spacers (100) Pkt	10
676865	5mm Large Economy Cross Spacers (500) Pkt	10
676867	5mm Large Economy Cross Spacers (1000) Pkt	10

**CROSS SPACERS - 8mm**

ITEM No.	DESCRIPTION	PACK SIZE
676869	8mm Large Economy Cross Spacers (100) Pkt	10

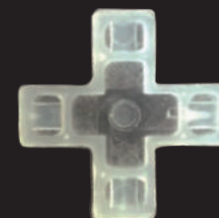
**CROSS SPACERS - 10mm**

ITEM No.	DESCRIPTION	PACK SIZE
676872	10mm Large Economy Cross Spacers (100) Pkt	10

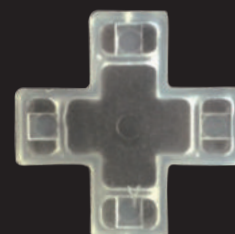



PREMIER T SPACERS

SMALL T-TILE SPACERS - 1.5mm - Ideal For Brick Patterns

ITEM No.	DESCRIPTION	PACK SIZE
676874	1.5mm Small T Spacers (100) Pkt	10
676876	1.5mm Small T Spacers (500) Pkt	10
676878	1.5mm Small T Spacers (1000) Pkt	10
676879	1.5mm Small T Spacers (3000) Bucket	12



MEDIUM T-TILE SPACERS - 3mm - Ideal For Brick Patterns

ITEM No.	DESCRIPTION	PACK SIZE
676880	3mm Medium T Spacers (100) Pkt	10
676882	3mm Medium T Spacers (500) Pkt	10
676884	3mm Medium T Spacers (2000) Bucket	12



LARGE T-TILE SPACERS - 5mm - Ideal For Brick Patterns

ITEM No.	DESCRIPTION	PACK SIZE
676885	5mm Large T Spacers (100) Pkt	10
676886	5mm Large T Spacers (500) Pkt	10



JUMBO T-TILE SPACERS - 10mm - Ideal For Brick Patterns

ITEM No.	DESCRIPTION	PACK SIZE
676889	10mm Jumbo T Spacers (100) Pkt	10
676890	10mm Jumbo T Spacers (500) Pkt	10



ECONOMY T SPACERS

T SPACERS - 1.5mm

ITEM No.	DESCRIPTION	PACK SIZE
676875	1.5mm Small Economy T Spacers (100) Pkt	10
676877	1.5mm Small Economy T Spacers (500) Pkt	10



T SPACERS - 3mm

ITEM No.	DESCRIPTION	PACK SIZE
676881	3mm Small Economy T Spacers (100) Pkt	10
676883	3mm Small Economy T Spacers (500) Pkt	10





SELF LEVELLING SPACERS

SELF-LEVEL SPACERS - 3-12mm

ITEM No.	DESCRIPTION	PACK SIZE
676897	Self Levelling Spacers 3-12mm (100) Pkt	1
676898	Self Levelling Spacers 3-12mm (200) Pkt	1
678146	Self Levelling Spacers 3-12mm (500) Bucket	1
695367	Self Levelling Spacers 3-12mm (1000) Bucket	1

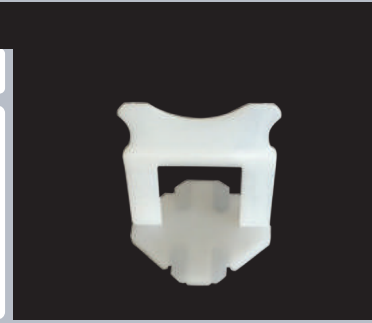

SELF-LEVEL SPACERS - 12-20mm

ITEM No.	DESCRIPTION	PACK SIZE
678147	Self Levelling Spacers 12-20mm (100) Pkt	1
678148	Self Levelling Spacers 12-20mm (200) Pkt	1

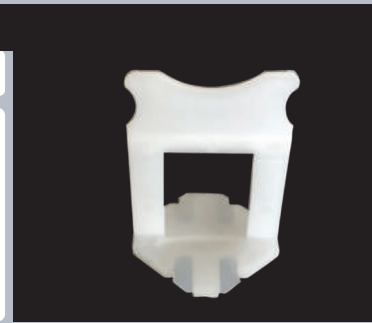

SELF LEVELLING WEDGES

WEDGES SELF-LEVELLING

ITEM No.	DESCRIPTION	PACK SIZE
678149	Wedges Self Levelling (100) Pkt	1

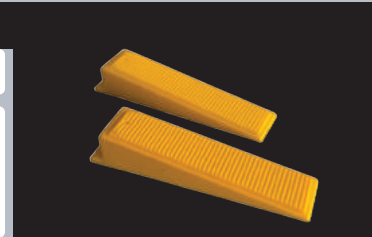

SMALL TILE WEDGES

SMALL TILE WEDGES - Premier

ITEM No.	DESCRIPTION	PACK SIZE
676891	Small Tile Wedges (100) Pkt	10
676893	Small Tile Wedges (500) Pkt	10
676895	Small Tile Wedges (2000) Bucket	10

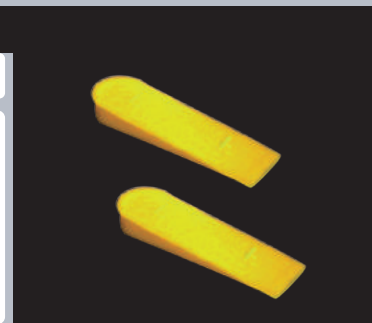

SMALL TILE WEDGES - Economy

ITEM No.	DESCRIPTION	PACK SIZE
676892	Small Tile Wedges Economy (100) Pkt	10
676894	Small Tile Wedges Economy (500) Pkt	10

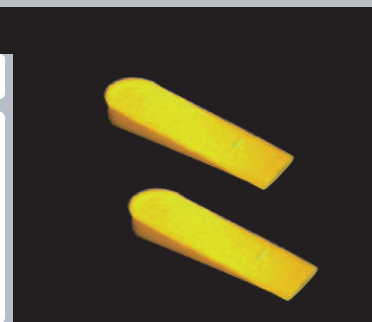

PLIERS FOR SELF LEVELLING

PLIER SET

ITEM No.	DESCRIPTION	PACK SIZE
678150	Pliers for Self-Leveling (1 set)	1





ATR SELF LEVELING SPACERS

SPINDLES

ITEM No.	PART No.	DESCRIPTION	PACK SIZE
695370	20S100	Red Spindle (100) Pkt	1
695371	20S50	Red Spindle (50) Pkt	1

The ATR spindle is universal. This means it fits all our our spacing plates.



UNIVERSAL FLOOR & WALL PLATES - 2mm BLUE

ITEM No.	PART No.	DESCRIPTION	PACK SIZE
695372	2UX100	2mm Blue Cross Plate (100)	1

The Cross spacing plate is where 4 tiles are adjacent to each other.



ITEM No.	PART No.	DESCRIPTION	PACK SIZE
695373	2UE100	2mm Blue Edge Plate (100)	1

The Edge spacing plate is where 2 tiles are adjacent to each other.



ITEM No.	PART No.	DESCRIPTION	PACK SIZE
695374	2UT100	2mm Blue T Plate (100)	1

The T spacing plate for use on brick pattern or offset installations - no special tools needed.



UNIVERSAL FLOOR & WALL PLATES - 3mm ORANGE

ITEM No.	PART No.	DESCRIPTION	PACK SIZE
695375	3UX100	3mm Orange Cross Plate (100)	1

The Cross spacing plate is where 4 tiles are adjacent to each other.

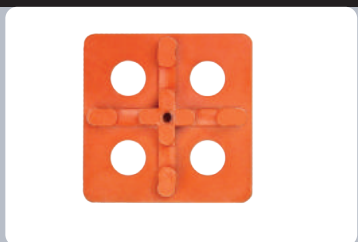

ITEM No.	PART No.	DESCRIPTION	PACK SIZE
695376	3UE100	3mm Orange Edge Plate (100)	1

The Edge spacing plate is where 2 tiles are adjacent to each other.



ITEM No.	PART No.	DESCRIPTION	PACK SIZE
695377	3UT100	3mm Orange T Plate (100)	1

The T spacing plate for use on brick pattern or offset installations - no special tools needed.





SPACERS, LEVELLING & WEDGES





ATR SELF LEVELING SPACERS

FLOOR PLATES - 3mm GREEN

ITEM No.	PART No.	DESCRIPTION	PACK SIZE	
695378	3FX100	3mm Green Cross Plate (100) <i>The Cross spacing plate is where 4 tiles are adjacent to each other.</i>	1	
695379	3FE100	3mm Green Edge Plate (100) <i>The Edge spacing plate is where 2 tiles are adjacent to each other.</i>	1	

FLOOR PLATES - 2mm WHITE

ITEM No.	PART No.	DESCRIPTION	PACK SIZE	
695380	2FX100	3mm White Cross Plate (100) <i>The Cross spacing plate is where 4 tiles are adjacent to each other.</i>	1	
695381	2FE100	3mm White Edge Plate (100) <i>The Edge spacing plate is where 2 tiles are adjacent to each other.</i>	1	

SOCKET BIT 10mm

ITEM No.	PART No.	DESCRIPTION	PACK SIZE	
695382	SOC100	Lime Colour Socket Bit (to fit red spindle) <i>The socket bit is guaranteed to securely fit the ATR Levelling Spindle.</i>	1	

**MAXISIL A- 310ml Tubes for Ceramics**

ITEM No.	DESCRIPTION	PACK SIZE
678002	Maxisil A - A1 Clear	20
678003	Maxisil A - A2 White	20
678004	Maxisil A - A3 Off White	20
678005	Maxisil A - A4 Light Grey	20
678006	Maxisil A - A5 Mid Grey	20
678323	Maxisil A - A7 Basalt	20
678321	Maxisil A - A8 Blue Grey	20
678325	Maxisil A - A9 Platinum	20
678007	Maxisil A - A10 Grey	20
678008	Maxisil A - A13 Anthracite	20
678009	Maxisil A - A15 Aluminium	20
678010	Maxisil A - A16 Black	20
678011	Maxisil A - A17 Alabaster	20
678103	Maxisil A - A18 Stone	20
678012	Maxisil A - A19 Ivory	20
678013	Maxisil A - A20 Travertine	20
678014	Maxisil A - A21 Sand	20
678324	Maxisil A - A22 Canvas	20
678015	Maxisil A - A23 Mid Beige	20
678016	Maxisil A - A24 Beige	20
678017	Maxisil A - A27 Mid Brown	20
678018	Maxisil A - A28 Brown	20
678019	Maxisil A - A29 Havana	20
678020	Maxisil A - A32 Cotto	20
678021	Maxisil A - A33 Red - (Indent Only)	20
678022	Maxisil A - A34 Burgundy - (Indent Only)	20
678023	Maxisil A - A36 Stella - (Indent Only)	20
678024	Maxisil A - A44 Bermunda	20
678025	Maxisil A - A45 Sorrento	20
678326	Maxisil A - A46 Snow White	20
678026	Maxisil A - A48 Green - (Indent Only)	20
678027	Maxisil A - A52 Mint - (Indent Only)	20
678327	Maxisil A - A53 Neutral	20
678028	Maxisil A - A55 Vanilla	20
678322	Maxisil A - A56 Pewter Grey	20
678331	Maxisil A - A57 Plover	20
678329	Maxisil A - A58 Mink	20
678328	Maxisil A - A60 Mocha	20
678330	Maxisil A - A61 Deep Terracotta	20
678029	Maxisil A - A62 Sienna	20
678332	Maxisil A - A63 Cinder	20





MAXISIL A - 310ml Tubes for Ceramics

Maxisil A - is designed especially for expansion joints for use in all sanitary areas, ceramic tiles in bathrooms, kitchens and flooring sectors

* Please note that color samples are not true to the actual colour. The below is a guide only.

					
CLEAR A1	WHITE A2	OFF WHITE A3	LIGHT GREY A4		
					
MID GREY A5	BASALT A7	BLUE GREY A8	PLATINUM A9		
					
GREY A10	ANTHRACITE A13	ALUMINIUM A15	BLACK A16		
					
ALABASTER A17	STONE A18	IVORY A19	TRAVERINE A20		
					
SAND A21	CANVAS A22	MID BEIGE A23	BEIGE A24		
					
MID BROWN A27	BROWN A28	HAVANA A29	COTTO A32		
					
*RED A33	*BURGUNDY A34	*STELLA A36	BERMUDA A44	SORRENTO A45	SNOW WHITE A46
					
*GREEN A48	*MINT A52	NEUTRAL A53	VANILLA A55	PEWTER GREY A56	PLOVER A57
					
MINK A58	MOCHA A60	DEEP TERRACOTTA A61	SIENNA A62	CINDER A63	



* Indent Only
(Minimum 1
Carton Orders)



MAXISIL N - 310ml Tubes for Natural Stone

ITEM No.	DESCRIPTION	PACK SIZE
678030	Maxisil N - N 1 Clear	20
678031	Maxisil N - N 2 White	20
678032	Maxisil N - N 3 Alabaster	20
678033	Maxisil N - N 4 Vanilla	20
678034	Maxisil N - N 5 Sand	20
678035	Maxisil N - N 6 Beige	20
678036	Maxisil N - N 9 Brown	20
678037	Maxisil N - N 11 Light Grey	20
678038	Maxisil N - N 12 Pearl Grey	20
678076	Maxisil N - N 13 Chinchilla	20
678039	Maxisil N - N 14 Manhattan	20
678040	Maxisil N - N 15 Grey	20
678041	Maxisil N - N 16 Dark Grey	20
678042	Maxisil N - N 17 Anthracite	20
678043	Maxisil N - N 18 Black	20
678068	Maxisil N - N 19 Rosa - (Indent Only)	20
678119	Maxisil N - N 20 Noce -(Indent Only)	20
678069	Maxisil N - N 22 Carrara	20
678065	Maxisil N - N 23 Grigio	20
678044	Maxisil N - N 27 Travertine	20
678045	Maxisil N - N 28 Havana	20
678335	Maxisil N - N 29 Matt White	20
678334	Maxisil N - N 30 Matt Black	20
678333	Maxisil N - N 31 Matt Anthracite	20



PRIMER N 1215

ITEM No.	DESCRIPTION	PACK SIZE
678085	PRIMER N 1215 250ml	





MAXISIL N - 310ml Tubes for Natural Stone

Maxisil N is a non-staining neutral cure silicone designed for expansion joints in natural stone e.g. Marble & Granite.

NOTE: N19 & N20 are available on indent only.

* Please note that colour samples are not true to the actual colour. The below is a guide only.

			
CLEAR N1	WHITE N2	ALABASTER N3	VANILLA N4
			
SAND N5	BEIGE N6	BROWN N9	LIGHT GREY N11
			
PEARL GREY N12	CHINCHILLA N13	MANHATTAN N14	GREY N15
			
DARK GREY N16	ANTHRACITE N17	BLACK N18	ROSA N19
			
NOCE N20	CARRARA N22	GRIGIO N23	TRAVERTINE N27
			
HAVANA N28	MATT WHITE N29	MATT BLACK N30	MATT ANTHRACITE N31





PRIMER P 1218

ITEM No.	DESCRIPTION	PACK SIZE
678066	PRIMER P 1218 250ml	



MAXISIL P - 310ml tubes

ITEM No.	DESCRIPTION	PACK SIZE
678057	MAXISIL P - P1 WHITE	20
678058	MAXISIL P - P2 OFF WHITE	20
678059	MAXISIL P - P3 LIGHT GREY	20
678060	MAXISIL P - P4 GREY	20
678061	MAXISIL P - P5 IVORY	20
678062	MAXISIL P - P6 SAND	20
678063	MAXISIL P - P7 BLACK	20
678064	MAXISIL P - P8 BLUE	20
678336	MAXISIL P - P9 CLEAR	20

Maxisil P is designed for swimming pools, water fountains, public showers, gymnasiums & all under water applications.











MAXISIL M - 310ml tubes

ITEM No.	DESCRIPTION	PACK SIZE
678129	Maxisil M- M3 Off White	20

Maxisil M is a neutral cure silicone sealant ideally suited for the use in waterproof membrane applications plus bathroom and general building requirements.

SILICONES



	WHITE P1		CLEAR P9
	OFF WHITE P2		
	LIGHT GREY P3		
	GREY P4		
	IVORY P5		OFF WHITE ONLY M3
	SAND P6		
	BLACK P7		
	BLUE P8		





CLEANERS AND ACCESSORIES

ITEM No.	DESCRIPTION	SIZE	PACK SIZE
678046	Smoothtex A	250mls	15
678047	Smoothtex A	1 Litre	6
678048	Smoothtex A	5 Litre	4



ITEM No.	DESCRIPTION	SIZE	PACK SIZE
678067	Smoothtex N	1 Litre	6
678049	Smoothtex N	5 Litre	4



ITEM No.	DESCRIPTION	SIZE	PACK SIZE
678054	Maxiclean A	250mls	20



ITEM No.	DESCRIPTION	SIZE	PACK SIZE
678052	Corner Nozzles - 3 Pack		6
678053	Extension Nozzles - 6 Pack		10



ITEM No.	DESCRIPTION	SIZE	PACK SIZE
678050	Silicone Applicator		6



ITEM No.	DESCRIPTION	SIZE	PACK SIZE
678051	Brush Standard		6



ITEM No.	DESCRIPTION	SIZE	PACK SIZE
678311	Caulk Gun Unblocker		10



ITEM No.	DESCRIPTION	SIZE	PACK SIZE
678310	Cartridge Cutter		10





Maxisil Spray Bottle 500ml

ITEM No.	DESCRIPTION	PACK SIZE
678070	Maxisil Spray Bottle 500ml	1



SPARKO HIGH TECH 100% NEUTRAL CURE - 290ml Tubes for Ceramics

ITEM No.	DESCRIPTION	PACK SIZE
678102	S1 Sparko White Neutral Cure	25
678108	S2 Sparko Grey Neutral Cure	25
678283	S3 Sparko Clear Neutral Cure	25

} Only sold in packs of 25

SILICONES





TILER'S MATE® SILICONES

Division of Gilt Edge Industries Ltd

TECNISEAL SILICONE - 310ml Tubes

ITEM No.	DESCRIPTION	PACK SIZE
678301	Techniseal A Silicone White A2	20
678302	Techniseal A Silicone Light Grey A4	20
678303	Techniseal A Silicone Mid Grey A5	20
678304	Techniseal A Silicone Alpine White A18	20
678305	Techniseal A Silicone Anthracite A13	20
678306	Techniseal A Silicone Black A16	20
678307	Techniseal A Silicone Dove White A3	20
678312	Techniseal A Silicone Manhattan A9	20
678313	Techniseal A Silicone Grey A10	20
678314	Techniseal A Silicone Ivory A19	20
678315	Techniseal A Silicone Mid Beige A23	20
678316	Techniseal A Silicone Beige A24	20
678317	Techniseal A Silicone Alabaster A17	20
678318	Techniseal A Silicone Vanilla A55	20



THE HIGH PERFORMANCE SILICONE SEALANT SYSTEM

SUPERIOR QUALITY

TECNI SEAL A

SILICONE SEALANT PLUS

A2
White

A3
Dove White

A9
Manhattan

A17
Alabaster

A23
Mid Beige

A41
Mid Blue

A1
Clear

A10
Grey

A55
Vanilla

A24
Beige

A44
Bermuda

A15
Aluminium

A18
Alpine White

A12
Dark Grey

A19
Ivory

A27
Mid Brown

A45
Dark Blue

A36
Stella

A4
Light Grey

A13
Anthracite

A21
Sand

A28
Brown

A52
Mint

A35
Red Gum

A5
Mid Grey

A16
Black

A30
Curry

A32
Cotto

A48
Green

A34
Jarah

ACETOXY CURE *Made in Germany exclusively for -*

PERFECT FOR BATHROOMS, LAUNDRIES, KITCHENS

Superior "Techniseal A" Features an Anti-Bacterial Agent and Powerful Fungicides for Mould Prevention and is UV Stable.

SILICONES







SEALERS

ITEM No.	DESCRIPTION	PACK SIZE	
	Sealer's Choice Gold - A premium, no sheen, natural look, water based, penetrating sealer formulated to provide maximum stain protection, especially in food preparation and serving areas.		
678179	Sealer's Choice Gold 473mls	12	
678180	Sealer's Choice Gold 946mls	4	
678181	Sealer's Choice Gold 3.78L	4	
678182	Sealer's Choice Gold 19L	1	
	Penetrating Sealer - An economical, no sheen, natural look, water based, penetrating sealer designed to resist stains.		
678194	Penetrating Sealer 946mls	4	
678195	Penetrating Sealer 3.78L	4	
678196	Penetrating Sealer 19L	1	
ITEM No.	DESCRIPTION	PACK SIZE	
	Ultra Solv - A premium, no sheen, natural look, solvent based, penetrating sealer formulated to provide maximum stain protection, especially in food preparation and serving areas.		
678183	Ultra Solv 946mls	4	
678184	Ultra Solv 3.78L	4	
ITEM No.	DESCRIPTION	PACK SIZE	
	Pro Solv - An economical, no sheen, natural look, solvent based, penetrating sealer formulated to resist stains on porous stone and tile.		
678192	Pro Solv 946mls	4	
678193	Pro Solv 3.78L	4	
ITEM No.	DESCRIPTION	PACK SIZE	
	Same Day Grout Sealer - A no sheen, natural look, water based, non-flammable, aerosol sealer with a 360° nozzle specifically formulated for grout.		
678191	Same Day Grout Sealer 443mls	12	
ITEM No.	DESCRIPTION	PACK SIZE	
	Grout Sealer - A water based sealer that resists water, oil and acid based contaminants.		
678188	Grout Sealer 237mls Spray Bottle	24	
678189	Grout Sealer 710ml Trigger Spray Bottle	4	







SEALERS

ITEM No.	DESCRIPTION	PACK SIZE	
678190	Grout Sealer Applicator Bottle - is ideal for use with the Aqua Mix line of sealers. The Aqua Mix Grout Sealer Applicator offers quick and easy application on counter-tops, walls, & floors. You'll get complete coverage of grout joints without the mess.	24	
678185	Enrich'N'Seal - A premium, no sheen, enhanced look 100% polymer solid, penetrating sealer formulated to darken, enrich and highlight the character and beauty of unsealed natural stone.	12	
678186	Enrich'N'Seal 473mls	4	
678187	Enrich'N'Seal 946mls Enrich'N'Seal 3.78L	4	
678200	High Gloss Sealer - A specially formulated water based sealer of acrylic polymers that provides both a stain resistant surface and durable high sheen finish eliminating the need for two products. (Interior Only)	4	
678201	High Gloss Sealer 946mls High Gloss Sealer 3.78L	4	
678197	Seal & Finish Low Sheen - A specially formulated water based blend of acrylic polymers that provides both a stain resistant surface seal and a durable low sheen finish eliminating conventional two step methods utilising a sealer and finish. (Interior/Exterior)	4	
678198	Seal & Finish Low Sheen 946mls	4	
678199	Seal & Finish Low Sheen 3.78L Seal & Finish Low Sheen 19L	1	
678202	Floor & Shine Hardener - A clear durable floor finish that resists surface abuse and leaves a beautiful high sheen finish. (Interior Only)	4	
678203	Floor & Shine Hardener 946mls Floor & Shine Hardener 3.78L	4	







CLEANERS

ITEM No.	DESCRIPTION	PACK SIZE	
678205	<p>AquaKleen - A ready to use, powerful, multi purpose tile and grout spray cleaner that cleans and deodorises kitchens and bathrooms.</p> <p>AquaKleen 710mls Trigger Bottle</p>	4	
678204	<p>AquaShield - A ready to use cleaner and resealer for natural stone.</p> <p>Aquashield 710mls Trigger Bottle</p>	4	
678206	<p>Stone Clean & Shine - A spray and buff cleaner that is designed to enhance the natural beauty of the stone as it cleans.</p> <p>Stone Clean & Shine 710mls Trigger Bottle</p>	4	
678211 678212	<p>Concentrated Stone & Tile Cleaner - A super concentrated cleaner formulated for everyday use. This neutral PH cleaner, when used regularly, prevents soap scum build up & hard water deposits. Biodegradable formula.</p> <p>Concentrated Stone & Tile Cleaner 946ml Concentrated Stone & Tile Cleaner 3.78L</p>	4 4	
678216	<p>Brilliance - A polishing cream and cleaner that nourishes and adds lustre to polished stone countertops and walls.</p> <p>Brilliance Counter Top Polish 237ml</p>	12	

SEALERS AND CLEANERS







CLEANERS

ITEM No.	DESCRIPTION	PACK SIZE	
	<u>Grout Deep Clean</u> - A powerful cleaner designed to remove grease, food stains, soap scum, hard water deposits, dirt and soil from grout joints. Biodegradable formula.		
678207	Grout Deep Clean 237mls Spray Bottle	24	
678208	Grout Deep Clean 710mls Trigger Bottle	4	
ITEM No.	DESCRIPTION	PACK SIZE	
	<u>Heavy Duty Tile & Grout Cleaner</u> - A concentrated high alkaline cleaner and degreaser. Effectively removes grease, soap scum and other organic materials from areas that have been neglected.		
678213	Heavy Duty Tile & Grout Cleaner 946ml	4	
678214	Heavy Duty Tile & Grout Cleaner 3.8L	4	
678215	Heavy Duty Tile & Grout Cleaner 19L	1	
ITEM No.	DESCRIPTION	PACK SIZE	
	<u>Stone Deep Clean</u> - A concentrated heavy duty cleaner and degreaser formulated to clean stone surfaces that have been neglected or subjected to heavy use. Biodegradable formula.		
678209	Stone Deep Clean 946ml	4	
678210	Stone Deep Clean 3.8L	4	
ITEM No.	DESCRIPTION	PACK SIZE	
	<u>1 & 2 Deep Clean</u> - An effective, highly concentrated, high alkaline, 2 part industrial strength cleaner & degreaser. Removes ground in dirt, grease and soap scum.		
678217	1 & 2 Deep Clean Set 3.6kg (Liquid & Powder)	2	





PROBLEM SOLVERS

ITEM No.	DESCRIPTION	PACK SIZE	
678230 678231	NanoScrub Cleaner - An abrasive cream cleaner designed to work where other cleaners won't. It utilises nano sized particles to penetrate into small surface pores where it can work effectively. NanoScrub 946mls NanoScrub 3.78L	4 4	
678226 678227	Grout Release - A temporary, water soluble, pre grout coating. It provides protection against grout and mortar staining and eases grout clean up. Grout Release 946mls Grout Release 3.78L	4 4	
678228 678229	Grout Haze Clean Up - A safe and effective concentrated cleaner that is added to the grout clean up water for removal of cementitious grout haze and latex additive film from tile during the grout clean up process and for grout haze removal upto 10 days after grouting. Grout Haze Clean Up 473mls Grout Haze Clean Up 3.78L	12 4	
678221 678222	Sulfamic Acid Crystals - A granular sulfamic acid to be dissolved in water. Removes cured grout and mortar haze, rust and mineral deposits including efflorescence. Sulfamic Acid Crystals 452gms Sulfamic Acid Crystals 2kg	6 6	
678218 678219	Cement Grout Haze Remover - An acidic treatment designed to remove grout haze upto 10 days after grouting, mineral deposits, rust stains, mortar smears and efflorescence. Cement Grout Haze Remover 946mls Cement Grout Haze Remover 3.78L	4 4	



PROBLEM SOLVERS

ITEM No.	DESCRIPTION	PACK SIZE	
678225	Poultice Stain Remover - A dual purpose, non acidic stain remover. It is an absorptive clay that is designed to remove deep set oil & grease stains without scrubbing.	6	
678220	Eff-Ex Efflorescence Remover - Removes & inhibits efflorescence. Eff-Ex is a non-acidic (pH 7.4), heavy-duty cleaner.	4	
678232	Ex-Treme - A non flammable, heavy viscosity acidic cleaner designed to remove years of accumulated discoloration from air pollution or carbon build up.	4	
678223 678224	Sealer & Coating Remover - A non flammable, multi purpose stripper formulated to stay wet longer which gives the product time to remove most sealers, epoxy grout haze, urethane coatings, synthetic finishes, adhesives & also paints.	4 4	



GROUTS

ITEM No.	DESCRIPTION	PACK SIZE
	<i>Grout Colorant - An easy to use waterborne epoxy that re-colours, seals and rejuvenates existing grout joints. Also simplifies ongoing grout cleaning.</i>	
678237	Grout Colourant Antique White	4
678238	Grout Colourant Beige 8oz/237mls	4
678239	Grout Colourant Black 8oz/237mls	4
678240	Grout Colourant Bright White	4
678241	Grout Colourant Buff 8oz/237mls	4
678242	Grout Colourant Canvas 8oz/237mls	4
678243	Grout Colourant Charcoal 8oz/237mls	4
678244	Grout Colourant Cinnamon 8oz/237mls	4
678245	Grout Colourant Cocoa 8oz/237mls	4
678246	Grout Colourant Light Grey	4
678247	Grout Colourant Linen White	4
678248	Grout Colourant Natural Grey	4
678249	Grout Colourant Navajo 8oz/237mls	4
678250	Grout Colourant Pewter 8oz/237mls	4
678251	Grout Colourant Pure White	4
678252	Grout Colourant Sand 8oz/237mls	4
678253	Grout Colourant Silver 8oz/237mls	4
678254	Grout Colourant Smoke 8oz/237mls	4
678255	Grout Colourant Wheat 8oz/237mls	4
678256	Grout Colourant White 8oz/237mls	4



GROUT COLORANT COLORS



* Please note the above colours are not true to the actual colour. The above is a guide only.

COLOURANT

ITEM No.	DESCRIPTION	PACK SIZE
	<i>Grout Colorant Pre Treat Cleaner - An effective ready to use cleaner designed to remove dirt, soil, soap scum and hard water deposits from grout joints. Prepares non-epoxy grout joints by lightly etching the surface for a superior Aqua Mix Grout Colorant bond.</i>	
678233	Grout Colorant Pre Treat Cleaner 237ml	8





XT range available profiles

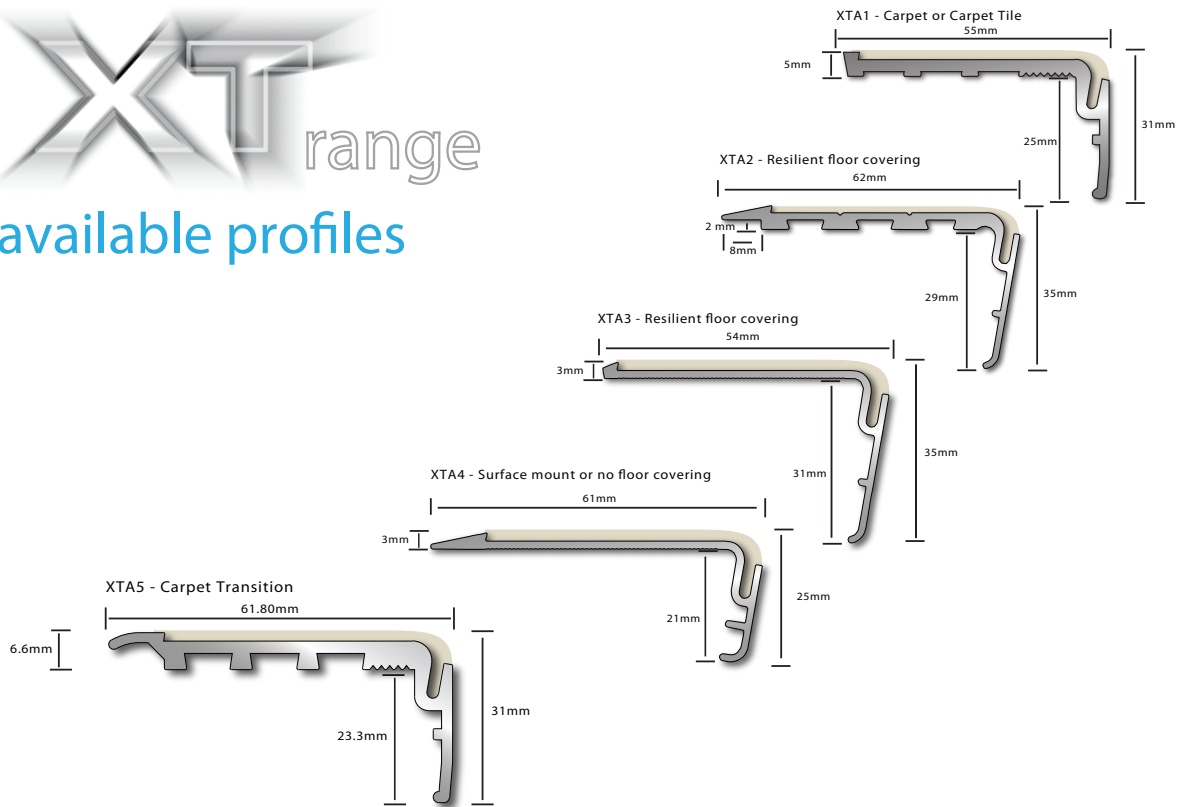

colour availability - ex stock

Jet



Snowdrift



Indent only

Ocean



Midnight



Poppy



Steel



Buttercup



Coffee



Evergreen



Lead



slip-resistance & performance

Pendulum Test Value (PTV)	Slip Potential
0 - 24	High Slip Potential
25 - 35	Moderate Slip Potential
36+	Low Slip Potential

Composition	PVC with Natural Mineral Fillers and PVC Wear Layer
Environment	Interior Dry Conditions
Potential for Slip	Dry Conditions Low (PTV Av. 68). Exceeds ALL minimum standards of specified slip resistance in accordance with AS/NZ 3661.1 and BIA D1/AS1
Compatibility	XT Profiles
Wear Classification	Group T - Class 34 - Commercial Very Heavy Group T - Class 43 - Light Industrial Heavy

cleaning & maintenance

IMPORTANT Do not use solvent cleaner of any description to clean Gradus products. Floor sealants and polishes should not be used as these will reduce slip-resistant properties and could prove hazardous. Particular care should be taken to avoid cross contamination occurring during the cleaning of other adjacent surfaces. Stair edgings provide an essential slip-resistant function and therefore a regular cleaning and maintenance programme is essential to avoid the build up of dirt and/or grease, which will be detrimental to the slip-resistance of the product.

For full cleaning and maintenance instructions contact Gilt Edge Industries Ltd.



GRADUS XT STAIRNOSING RANGE

ITEM No.	DESCRIPTION	
XTA1	XTA1 - Carpet or Carpet Tile	
XTA2	XTA2 - Resilient Floor Covering	
XTA3	XTA3 - Resilient Floor Covering	
XTA4	XTA4 - Surface Mount or No Flooring Covering	
XTA5	XTA5 - Carpet Transition	

GRADUS STAIRNOSING



GRADUS



STANDARD PROFILE RANGE (NON XT) SPECIFICATION GUIDE

CODE	PROFILE TYPE	INSERT	DESCRIPTION	TOP WIDTH	DROP (MM)	CODE	PROFILE TYPE	INSERT	DESCRIPTION	TOP WIDTH	DROP (MM)
SC2		2x38mm	Double Square	85	25	SM2		2x38mm	Double Bullnose	82	31
SC1		1x44mm	Single Square	52	25	SM1		1x44mm	Single Bullnose	48	31
SD2		2x38mm	Double Rakeback	85	36	CD1		1x63mm	Single Square Carpet	84	31
SD1		1x44mm	Single Rakeback	52	37	CD2		3x12mm	Triple Insert Carpet	65	36
LF3		1x44mm	Single Longface	56	44	CD3		1x44mm	Single Longface Carpet	61	46
LF2		2x38mm	Double Longface	88	43	CD4		1x44mm	Single Square Carpet	62	31
LF1		1x44mm	Single Longface	52	44	PV1		1x44mm	Rigid PVC Carpet	65	31
RP2		1x44mm	Single Threshold Aluminium	53	-	PV2		1x44mm	Rigid PVC Carpet	54	36
RP1		1x44mm	Single Ramp Edge	59	23						

GRADUS INSERT COLOUR:

Burgundy Buttercup Coffee Evergreen Jet Ocean Poppy Snowdrift Steel



Custom colours available on request.

GREASE RESISTANT / OUTDOOR INSERTS: In any installation location where contaminants such as oils, grease and fats are likely to be trafficked onto stair nosings, the GRADUS Grease Resistant Outdoor Insert must be used.

COMPLETE FIXING KIT: Price includes anti-slip insert which is fitted after fixing of aluminium or PVC nosing profile, in addition to screws and fixing plugs. Adhesive also available. Nosings should always be adhesive and mechanically fixed.

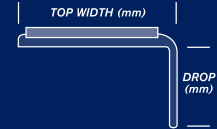

STAIR NOSING / STAIR TILE INSTALLATION GUIDE

PROFILE	CARPET	LINOLEUM VINYL	TILE-CERAMIC or TEROCOTTA ETC.	CONCRETE	TIMBER	MARBLE TERRAZZO
SC2	P	I	P	I	I	P
SC1	P	I	P	I	I	P
SD2	P	I	P	I	I	P
SD1	P	I	P	I	I	P
SM2	P	I	P	I	I	P
SM1	P	I	P	I	I	P
LF3	P	I	P	U	U	U
LF2	P	I	P	I	I	P
LF1	P	I	P	I	I	P
CD1	I	U	P	U	U	U
CD2	I	U	P	U	U	U
CD3	I	U	P	U	U	U
CD4	I	U	P	U	U	U
RP2	U	I	P	I	I	P
RP1	U	P	P	I	I	I
PV1	I	U	P	U	U	U
PV2	P	I	P	I	I	I
STAIR TILE	U	U	I	I	I	I











NOTE: The above is a guideline only. "Possible" indicates that whilst not technically the most suitable profile, it can be used with good results. Please contact Gilt Edge Industries for further clarification. Floor type "Carpet" includes direct and double stick as well as conventional installations.

KEY: I Ideal P Possible U Unsuitable

TO ORDER FREE FAX 0800 103 649



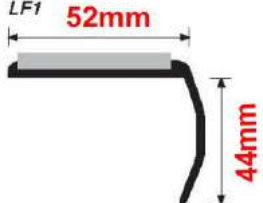







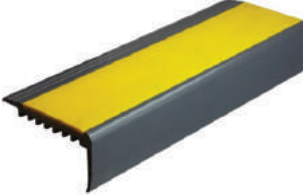
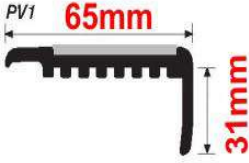
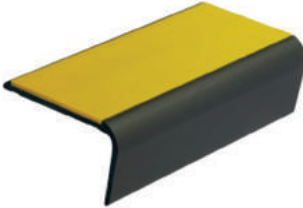

GRADUS STANDARD STAIRNOSING RANGE

ITEM NO.	DESCRIPTION	
CD1	Single Square Carpet	 
CD2	Triple Insert Carpet	 
CD3	Single Longface Carpet	 
CD4	Single Square Carpet	 
LF1	Single Longface	 
LF2	Double Longface	 



GRADUS STANDARD STAIRNOSING RANGE

ITEM NO.	DESCRIPTION	
LF3	Single Longface	 
PV1	Rigid PVC Carpet	 
PV2	Rigid PVC Carpet	 
RP1	Single Ramp Edge	 
RP2	Single Threshold Aluminium	 
SC1	Single Square	 



GRADUS STANDARD STAIRNOSING RANGE

ITEM NO.	DESCRIPTION	
SC2	Double Square	
SD1	Single Rakeback	
SD2	Double Rakeback	
SM1	Single Bullnose	
SM2	Double Bullnose	
SN3	Black PVC Stairnosing	

GRADUS STAIRNOSING



GRADUS STAIRTILE RANGE

- * Anti-slip insert material for use in Concrete, Marble, Timber & Terrazzo.
- * Stock colours = Black. Brown, White & Yellow available indent ex U.K.
- * Thickness 8mm (plus/minus 0.5mm) . 6.5mm INDENT ONLY
- * Custom Fabrication available upon request.

ITEM No.	DESCRIPTION	
OT25F1.219 OT25F1.525 OT25F1.83	Stairtile Flat Profile 1.219mtr Stairtile Flat Profile 1.525mtr Stairtile Flat Profile 1.83mtr	
ITEM No.	DESCRIPTION	
OT38F1.219 OT38F1.525 OT38F1.83	Stairtile Flat Profile 1.219mtr Stairtile Flat Profile 1.525mtr Stairtile Flat Profile 1.83mtr	
ITEM No.	DESCRIPTION	
OT51F1.219 OT51F1.525 OT51F1.83	Stairtile Flat Profile 1.219mtr Stairtile Flat Profile 1.525mtr Stairtile Flat Profile 1.83mtr	
ITEM No.	DESCRIPTION	
OT25D1.219 OT25D1.525 OT25D1.83	Stairtile Dovetail Profile 1.219mtr Stairtile Dovetail Profile 1.525mtr Stairtile Dovetail Profile 1.83mtr	
ITEM No.	DESCRIPTION	
OT38D1.219 OT38D1.525 OT38D1.83	Stairtile Dovetail Profile 1.219mtr Stairtile Dovetail Profile 1.525mtr Stairtile Dovetail Profile 1.83mtr	
ITEM No.	DESCRIPTION	
OT51D1.219 OT51D1.525 OT51D1.83	Stairtile Dovetail Profile 1.219mtr Stairtile Dovetail Profile 1.525mtr Stairtile Dovetail Profile 1.83mtr	
ITEM No.	DESCRIPTION	
OT51R1.219 OT51R1.525 OT51R1.83	Stairtile Rounded Profile 1.219mtr Stairtile Rounded Profile 1.525mtr Stairtile Rounded Profile 1.83mtr	
ITEM No.	DESCRIPTION	
OT51RDG1.219 OT51RDG1.525 OT51RDG1.83	Stairtile Round with Grooved Base 1.219mtr Stairtile Round with Grooved Base 1.525mtr Stairtile Round with Grooved Base 1.83mtr	



TILER'S MATE[®]

Division of Gilt Edge Industries Ltd

www.tilersmate.co.nz